



**Model 130B40**

**ICP® ELECTRET SURFACE MICROPHONE**

**Installation and Operating Manual**

**For assistance with the operation of this product,  
contact PCB Piezotronics, Inc.**

**Toll-free: 800-828-8840  
24-hour SensorLine: 716-684-0001  
Fax: 716-684-0987  
E-mail: [info@pcb.com](mailto:info@pcb.com)  
Web: [www.pcb.com](http://www.pcb.com)**



## Repair and Maintenance

PCB guarantees Total Customer Satisfaction through its “Lifetime Warranty Plus” on all Platinum Stock Products sold by PCB and through its limited warranties on all other PCB Stock, Standard and Special products. Due to the sophisticated nature of our sensors and associated instrumentation, **field servicing and repair is not recommended and, if attempted, will void the factory warranty.**

Beyond routine calibration and battery replacements where applicable, our products require no user maintenance. Clean electrical connectors, housings, and mounting surfaces with solutions and techniques that will not harm the material of construction. Observe caution when using liquids near devices that are not hermetically sealed. Such devices should only be wiped with a dampened cloth—never saturated or submerged.

In the event that equipment becomes damaged or ceases to operate, our Application Engineers are here to support your troubleshooting efforts 24 hours a day, 7 days a week. Call or email with model and serial number as well as a brief description of the problem.

## Calibration

Routine calibration of sensors and associated instrumentation is necessary to maintain measurement accuracy. We recommend calibrating on an annual basis, after exposure to any extreme environmental influence, or prior to any critical test.

PCB Piezotronics is an ISO-9001 certified company whose calibration services are accredited by A2LA to ISO/IEC 17025, with full traceability to SI through N.I.S.T. In addition to our standard calibration services, we also offer specialized tests, including: sensitivity at elevated or cryogenic temperatures, phase response, extended high or low frequency response, extended range, leak testing, hydrostatic pressure testing, and others. For more information, contact your local PCB Piezotronics distributor, sales representative, or factory customer service representative.

## Returning Equipment

If factory repair is required, our representatives will provide you with a Return Material Authorization (RMA) number, which we use to reference any information you have already provided and expedite the repair process. This number should be clearly marked on the outside of all returned package(s) and on any packing list(s) accompanying the shipment.

## Contact Information

PCB Piezotronics, Inc.  
3425 Walden Ave.  
Depew, NY14043 USA  
Toll-free: (800) 828-8840  
24-hour SensorLine: (716) 684-0001  
General inquiries: [info@pcb.com](mailto:info@pcb.com)  
Repair inquiries: [rma@pcb.com](mailto:rma@pcb.com)

For a complete list of distributors, global offices and sales representatives, visit our website, [www.pcb.com](http://www.pcb.com).

## Safety Considerations

This product is intended for use by qualified personnel who recognize shock hazards and are familiar with the precautions required to avoid injury. While our equipment is designed with user safety in mind, the protection provided by the equipment may be impaired if equipment is used in a manner not specified by this manual.

Discontinue use and contact our 24-Hour Sensorline if:

- Assistance is needed to safely operate equipment
- Damage is visible or suspected
- Equipment fails or malfunctions

For complete equipment ratings, refer to the enclosed specification sheet for your product.

## Definition of Terms and Symbols

The following symbols may be used in this manual:



### **DANGER**

Indicates an immediate hazardous situation, which, if not avoided, may result in death or serious injury.

**CAUTION**

Refers to hazards that could damage the instrument.

**NOTE**

Indicates tips, recommendations and important information. The notes simplify processes and contain additional information on particular operating steps.

**The following symbols may be found on the equipment described in this manual:**



This symbol on the unit indicates that high voltage may be present. Use standard safety precautions to avoid personal contact with this voltage.



This symbol on the unit indicates that the user should refer to the operating instructions located in the manual.



This symbol indicates safety, earth ground.



PCB工业监视和测量设备 - 中国RoHS2公布表

PCB Industrial Monitoring and Measuring Equipment - China RoHS 2 Disclosure Table

部件名称	有害物质					
	铅 (Pb)	汞 (Hg)	镉 (Cd)	六价铬 (Cr(VI))	多溴联苯 (PBB)	多溴二苯醚 (PBDE)
住房	0	0	0	0	0	0
PCB板	X	0	0	0	0	0
电气连接器	0	0	0	0	0	0
压电晶体	X	0	0	0	0	0
环氧	0	0	0	0	0	0
铁氟龙	0	0	0	0	0	0
电子	0	0	0	0	0	0
厚膜基板	0	0	X	0	0	0
电线	0	0	0	0	0	0
电缆	X	0	0	0	0	0
塑料	0	0	0	0	0	0
焊接	X	0	0	0	0	0
铜合金/黄铜	X	0	0	0	0	0
本表格依据 SJ/T 11364 的规定编制。						
0：表示该有害物质在该部件所有均质材料中的含量均在 GB/T 26572 规定的限量要求以下。						
X：表示该有害物质至少在该部件的某一均质材料中的含量超出 GB/T 26572 规定的限量要求。						
铅是欧洲RoHS指令2011/65/ EU附件三和附件四目前由于允许的豁免。						

CHINA RoHS COMPLIANCE

Component Name	Hazardous Substances					
	Lead (Pb)	Mercury (Hg)	Cadmium (Cd)	Chromium VI Compounds (Cr(VI))	Polybrominated Biphenyls (PBB)	Polybrominated Diphenyl Ethers (PBDE)
Housing	O	O	O	O	O	O
PCB Board	X	O	O	O	O	O
Electrical Connectors	O	O	O	O	O	O
Piezoelectric Crystals	X	O	O	O	O	O
Epoxy	O	O	O	O	O	O
Teflon	O	O	O	O	O	O
Electronics	O	O	O	O	O	O
Thick Film Substrate	O	O	X	O	O	O
Wires	O	O	O	O	O	O
Cables	X	O	O	O	O	O
Plastic	O	O	O	O	O	O
Solder	X	O	O	O	O	O
Copper Alloy/Brass	X	O	O	O	O	O

This table is prepared in accordance with the provisions of SJ/T 11364.

O: Indicates that said hazardous substance contained in all of the homogeneous materials for this part is below the limit requirement of GB/T 26572.

X: Indicates that said hazardous substance contained in at least one of the homogeneous materials for this part is above the limit requirement of GB/T 26572.

Lead is present due to allowed exemption in Annex III or Annex IV of the European RoHS Directive 2011/65/EU.

## OPERATING GUIDE FOR 130B SERIES SURFACE MICROPHONES

### *Contents:*

1.0	Introduction .....	1
2.0	Product Description .....	1
3.0	Powering .....	2
4.0	Installation and Operation .....	3
4.1.	Mounting Methods .....	3
4.2.	Mounting Procedure .....	5
4.3.	Operation .....	6
5.0	Calibration .....	6
6.0	Service .....	7
7.0	Warranty .....	7



**Figure 1: 130B40 Surface Microphone**

### **1.0 Introduction**

Congratulations on the purchase of a quality ICP<sup>®</sup> Microphone. In order to ensure the highest level of performance of the Microphone, we recommend that you follow the product's basic installation and operation procedures. By following these procedures and using this Microphone in conjunction with other PCB equipment (Signal Controllers, Power Supplies, Cables, Calibrators, etc.), you will ensure years of trouble free usage. If after reading this manual, you have additional questions concerning the Microphone or its application, feel free to call a factory Application Engineer at 716-684-0001, or your local dedicated PCB Sales Engineer.

### **2.0 Product Description**

The PCB 130B series of Surface Microphones are prepolarized, condenser microphones coupled with ICP<sup>®</sup> sensor powered preamps and are thus referred to as ICP<sup>®</sup> microphones. This eliminates the need to purchase a separate preamplifier. The 130B40 Surface Microphone provides an extremely cost effective method for making general purpose measurements on flat and curved surfaces subjected to air movement. Typical applications include measuring wind-induced noise on ground and airborne vehicles, acoustic radiation from surfaces, and noise tests in wind tunnels, as well as comparing the external noise on a moving vehicle with its internal noise, along with other applications. The low profile of the 130B40 Microphones (0.126"/3.2 mm) allows their use in tight-fitting places where other microphones would not fit.

Each 130B series Microphone can measure audio frequencies ranging from 20 Hz to 20 kHz, with a broad dynamic range from 32 dBA to 142 dB. See Figure 2. The Microphone has a built-in TEDS (Transducer Electronics Data Sheet) chip that provides the unit's sensitivity, calibration date, location and other data for traceability. Its light weight minimizes the impact of its mass loading on thin material and facilitates using only a thin, double-sided adhesive pad (provided) to attach the microphone, and its fairing when needed, to the test surface. The Microphone uses a front vent for pressure equalization, making it an excellent choice when it is used on aircraft and on road vehicles in mountainous terrain, and also allowing for adhesive or flush mounting. Additionally, the mesh of the microphone's protective grid repels water.

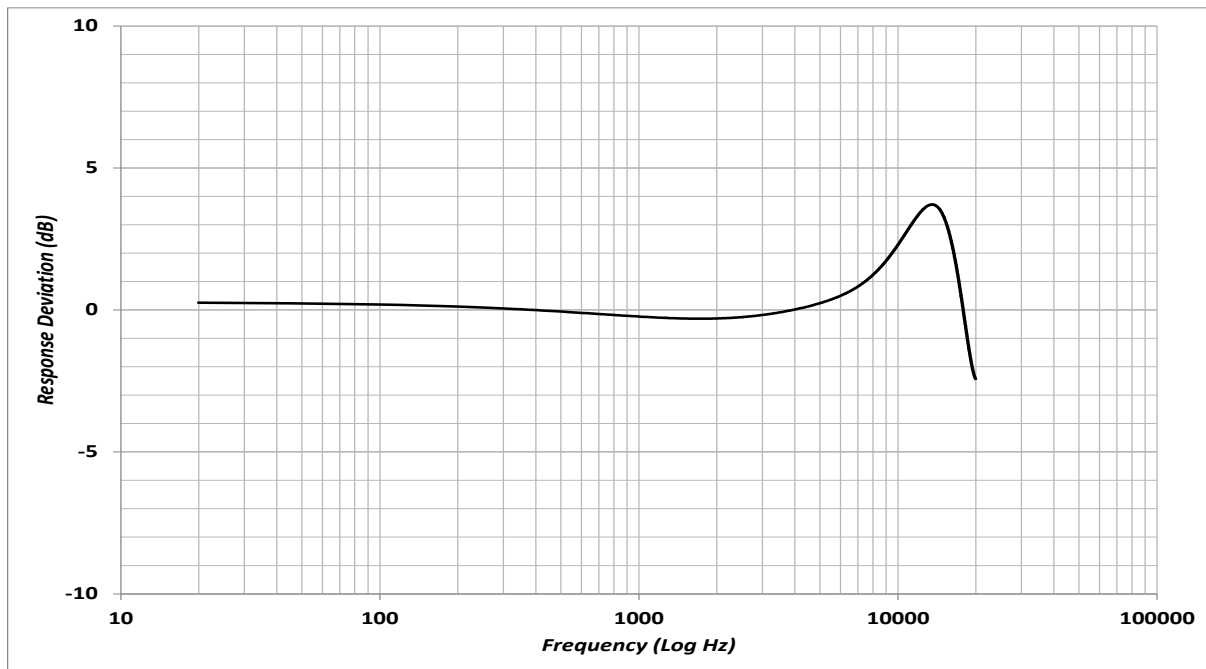

**Figure 2: Typical pressure frequency response curve of Series 130B Series Surface Microphones**

### 3.0 Powering

All ICP<sup>®</sup> powered microphones require the correct constant-current excitation for proper operation. For this reason, use only PCB constant-current signal conditioners or other approved constant-current sources. The signal conditioner consists of a regulated, 18–30 VDC source. The power is regulated by a current-limiting circuit, which provides the constant current excitation required for proper operation of the ICP<sup>®</sup> microphone. In general, battery powered devices offer versatility for portable low-noise measurements, whereas line-powered units provide the capability for continuous monitoring. A typical system schematic is shown in Figure 3.

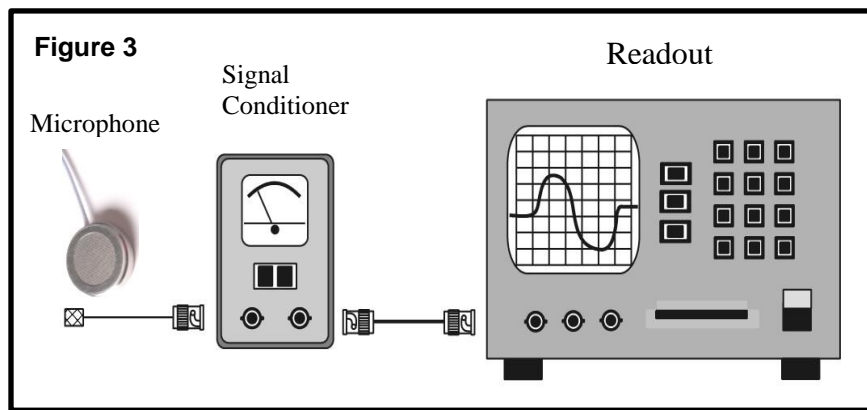

NOTE: Under no circumstances should a voltage be supplied to an ICP<sup>®</sup> microphone without a current-regulating diode or equivalent electrical circuit. This may include ohmmeters, multi-meters and continuity testers. Damage to the built-in electronics resulting from the application of incorrect power, or the use of an unapproved power source is NOT covered under warranty.

Certain models of signal conditioners have Meters or LEDS, which enable users to monitor the bias voltage output signal, check microphone operation, and detect cable faults. Normally, a “yellow” reading indicates an open circuit (e.g., a disconnected cable); “green” indicates normal operation and a “red” reading indicates a short circuit (e.g., a shorted cable). The signal conditioner provides a zero-based, AC-coupled output signal that is compatible with most standard readout devices.

Today, many FFT analyzers, data acquisition modules, and data collectors have the proper constant-current excitation built-in for direct use with ICP<sup>®</sup> microphones. Before using this feature, check that the supply voltage and constant current are within acceptable limits for use with your particular microphone. (Check enclosed **Specification Sheet**.) Consult the Vibration Division’s product catalog for more information about signal conditioners.

## 4.0 Installation and Operation

### 4.1. Mounting Methods

Consider the expected air flow across the surface on which the Surface Microphone will be mounted to determine the best way to secure the microphone to the surface. See Figure 4. When no air movement is expected, the double-sided adhesive pad, trimmed to the size of the microphone if desired, is adequate. For low air flow speeds, such as on the side of a vehicle, include the Fairing along with the double-sided adhesive pad to mount the microphone. At moderate to heavy air flow speeds, such as in a wind tunnel, add the single-sided adhesive pad on top of the Fairing. See Figure 5. Regardless of the mounting method, the Surface Microphone’s profile will not exceed 3.2 mm.



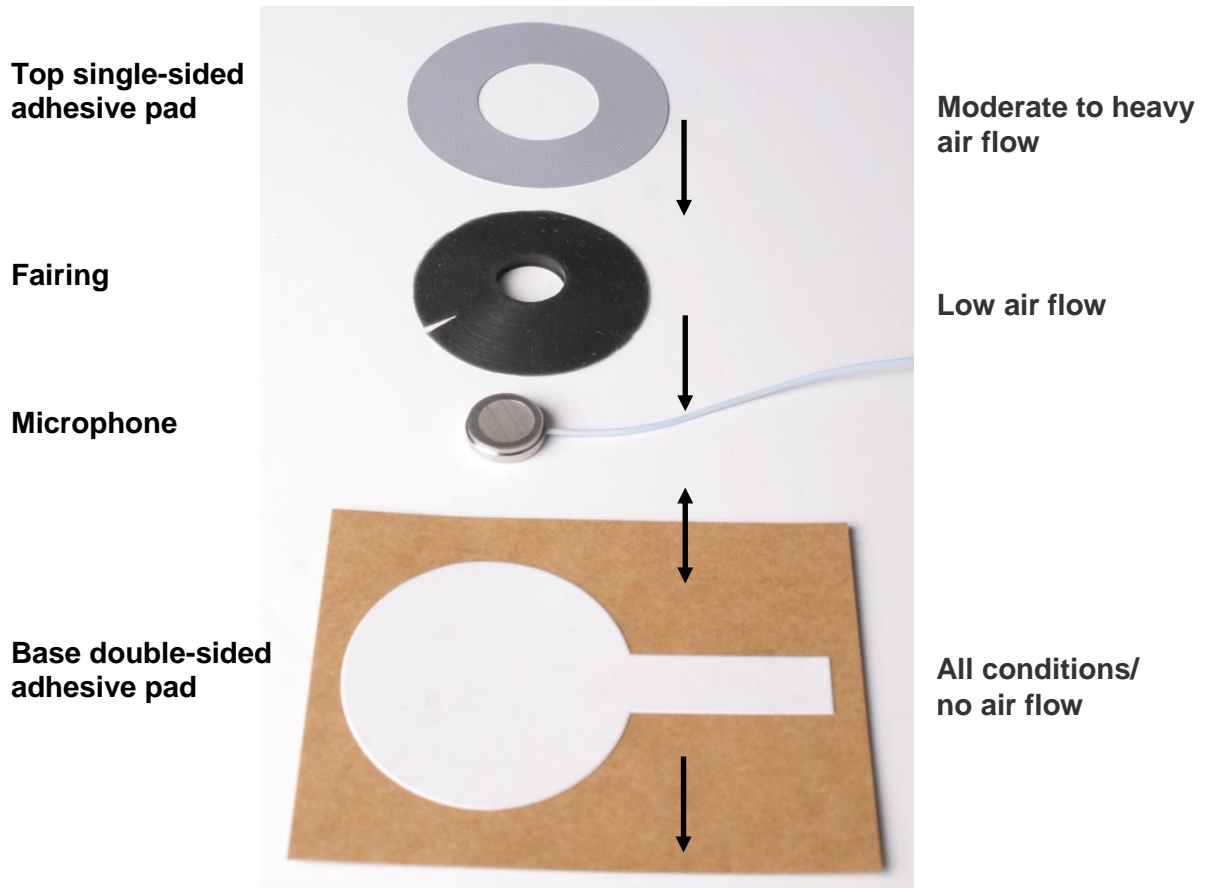

**Figure 4: Methods of securing the Surface Microphone to its mounting surface**

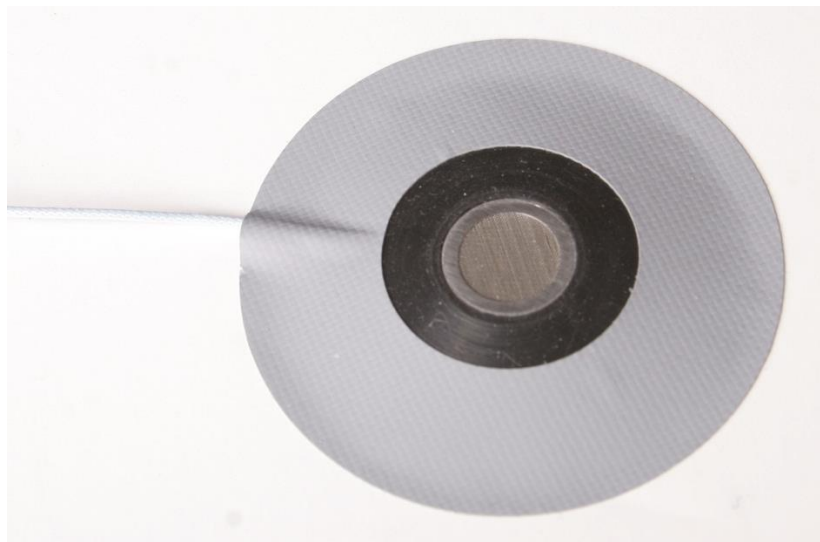

**Figure 5: One sided Adhesive Pad securing the Surface Microphone and Fairing in place**

## 4.2. Mounting Procedure

- 1) Use the cleansing tissue (provided) to clean the location where the Surface Microphone will be mounted. (Alternatively, clean the surface with isopropanol or cleaning benzene.)
- 2) To attach the Surface Microphone using the double-sided adhesive pad (see Figure 6), peel off the protective paper on one side of the pad to expose its adhesive surface, apply firmly to the underside of the microphone, then peel off the protective paper on the other side of the pad to expose the other adhesive surface, and press it onto the clean surface.

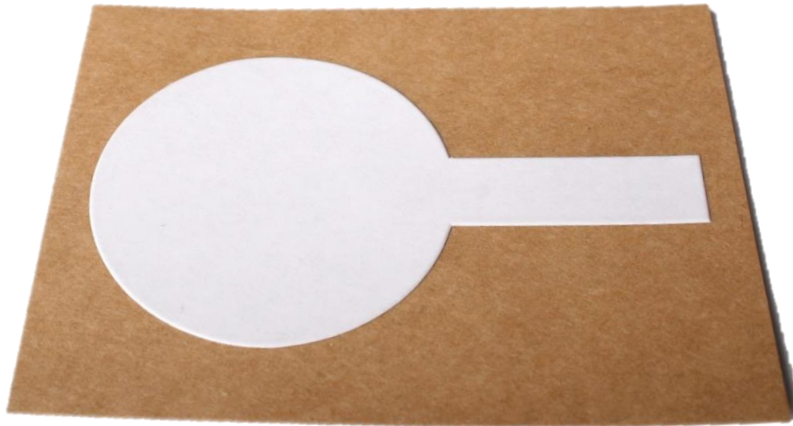

**Figure 6: Double-sided adhesive pad**

NOTE: If the Surface Microphone will be mounted in a location where no air movement is expected, the pad can be trimmed beforehand to fit the microphone if desired. If the Microphone will be mounted in moving air and will thus require use of the Fairing, center the microphone on the pad to ensure adhesion of the Fairing.

- 3) When the Surface Microphone will be mounted in a location where air movement is expected, attach the Fairing: align the Fairing's slot with the Microphone's cable and press the Fairing down over the microphone and onto the exposed adhesive surface of the double-sided adhesive pad, smoothing out the Fairing as necessary. See Figure 7.

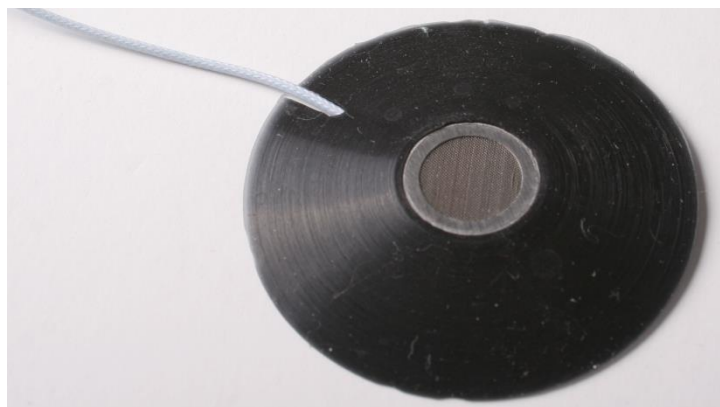

**Figure 7: Fairing installed over Surface Microphone**

- 4) To attach the single-sided adhesive pad (see Figure 8) when the Surface Microphone will be used in moderate to heavy air flow, peel off the protective paper to expose the pad's adhesive surface and press it onto the Fairing as shown in Figure 5.

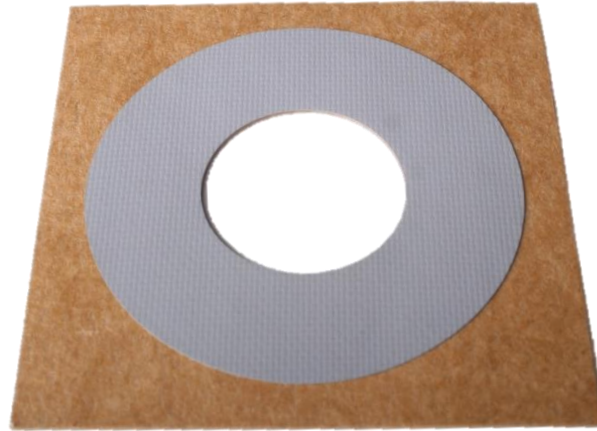

**Figure 8: Single sided adhesive pad**

### **4.3. Operation**

After completing the system setup, switch the signal conditioner on and allow 1 to 2 minutes for the system to stabilize. The meter (or LED) on the signal conditioner should be reading “green”. This indicates proper operation and you may begin taking measurements. If a faulty condition is indicated (red or yellow reading), first check all system connections, then check the functionality of the cable and signal conditioner. If the system still does not operate properly, consult a PCB factory representative.

### **5.0 Calibration**

All PCB microphones come with certificate of calibration and compliance with ISO 9001, and ANSI/NCSL Z540.3. The microphone is traceable to one or more of the following National Labs (NIST, PTB or DFM), and calibration records are on file. PCB utilizes the “Back-to-Back Reference” form of calibration. The microphone is checked against a test and measurement working standard microphone and must meet specifications before it can be shipped. An example of the result of one of the tests is shown above.

See Figure 2.

Microphone calibration provides, with a definable degree of accuracy, the necessary link between the physical quantity being measured and the electrical signal generated by the microphone. In addition, other useful information concerning operational limits, physical parameters, electrical characteristics or environmental influences may be determined. Under normal conditions, microphones are very stable. However, the microphone may be temporarily or permanently affected by harsh influences, such as moisture, dirt, being dropped accidentally or other unusual conditions that may cause the microphone accuracy to deviate from the normal specifications. This may manifest itself in a number of ways, ranging from a loss in frequency range to total failure of the built-in microelectronic circuit due to high mechanical shock.

It is for this reason that PCB recommends that a recalibration cycle be established for each microphone. This schedule is unique and is based upon a variety of factors, such as: extent of use, environmental conditions, accuracy requirements, trend information obtained from previous

calibration records, contractual regulations, and risk associated with incorrect readings. PCB recommends 12 to 24 month intervals, depending upon the above factors. Contact your PCB representative to schedule factory recalibration of your microphone, or you can also calibrate the microphone on site using PCB's handheld CAL250 Acoustic Calibrator.

In addition, environmental factors will impact the microphone's sensitivity. Changes in temperature, humidity and atmospheric pressure can cause a microphone's sensitivity to change. To account for this, many end users perform a single-point sensitivity, in-the-field calibration. To perform this calibration for the 130B40 Microphone we recommend using a handheld CAL250 Acoustic Calibrator.

If you have a handheld calibrator, before performing a calibration, ensure the microphone has stabilized in the environment in which it will be used. This can take a few seconds to a few minutes, depending upon the extent of the environmental change. To perform the calibration, install the fairing pad onto the 130B40 Surface Microphone to help ensure a proper seal. Place the microphone and fairing pad on a flat, level surface. Turn the handheld calibrator upside down, and place the 1" (25mm without the adapters) opening onto the fairing, centered around the microphone sensing element. Press down slightly to ensure a seal and to minimize outside noise, then perform the calibration using the instructions provided in the calibrator's manual.

## 6.0 Service

See the supplemental sheet, contained with this manual, for information on our service, repair and return policies, procedures and instructions. When unexpected problems arise, call our 24-Hour SensorLine<sup>SM</sup> (716-684-0001) to discuss your immediate dynamic instrumentation needs with a factory representative.

## 7.0 Warranty

All equipment and repair services provided by PCB Piezotronics, Inc. are covered by a limited warranty against defective material and workmanship for a period of one year. Contact PCB for a complete statement of our warranty.

PCB guarantees **Total Customer Satisfaction**. If, at any time, for any reason, you are not completely satisfied with any PCB product, PCB will repair, replace, or exchange it at no charge. You may also choose within the warranty period to have your purchase price refunded.

3425 Walden Avenue, Depew, NY 14043-2495	24-hour SensorLine <sup>SM</sup> : 716-684-0001
E-Mail: <a href="mailto:info@pcb.com">info@pcb.com</a>	Fax: 716-685-3886
Website: <a href="http://www.pcb.com">www.pcb.com</a>	Toll-free (U.S.A.): 800-828-8840

A PCB GROUP COMPANY    ISO 9001 CERTIFIED    A2LA ACCREDITED to ISO 17025



© 2013 PCB Group, Inc. In the interest of constant product improvement, specifications are subject to change without notice.

PCB and ICP are registered trademarks of PCB Group, Inc. SensorLine is a service mark of PCB Group, Inc.

Manual Number: 56071  
Manual Revision: C  
ECO#: 42623



VIB-130B Manual – 09-13  
Printed in the U.S.A.

Model Number <b>130B40</b>	<b>ICP® ELECTRET SURFACE MICROPHONE</b>		Revision: D ECN #: 43176										
<b>Performance</b> Frequency Response Characteristic Frequency Response(+/-1 dB) Frequency Response(+/-3 dB) Frequency Response(+/-6 dB) Sensitivity(@ 250 Hz) Sensitivity(+/-3 dB)(@ 250 Hz) Inherent Noise Dynamic Range(High) Dynamic Range(3% Distortion Limit) TEDS Compliant(Per IEEE 1451.4)	<b>ENGLISH</b> Pressure 100 to 3000 Hz 20 to 10,000 Hz 20 to 20,000 Hz 8.5 mV/Pa -41.4 dB re 1 V/Pa <32 dB(A) re 20 µPa 150 dB re 20 µPa >142 dB re 20 µPa Yes	<b>SI</b> Pressure 100 to 3000 Hz 20 to 10,000 Hz 20 to 20,000 Hz 8.5 mV/Pa -41.4 dB re 1 V/Pa <32 dB(A) re 20 µPa 150 dB re 20 µPa >142 dB re 20 µPa Yes	<b>OPTIONAL VERSIONS</b> Optional versions have identical specifications and accessories as listed for the standard model except where noted below. More than one option may be used.										
<b>Environmental</b> Temperature Range(Operating) Influence of Axial Vibration(0.1g (1 m/s <sup>2</sup> ))	-40 to +176 °F 4.5 dB re 20 µPa	-40 to +80 °C 4.5 dB re 20 µPa	<b>NOTES:</b> [1]Sensitivity can change with significant variations in temperature. [2]Typical. [3]Max without clipping. [4]See PCB Declaration of Conformance PS023 for details.										
<b>Electrical</b> Excitation Voltage Constant Current Excitation Output Bias Voltage Output Impedance	18 to 30 VDC 2 to 20 mA 9 to 14 VDC ≤ 50 Ohm	18 to 30 VDC 2 to 20 mA 9 to 14 VDC ≤ 50 Ohm	<b>SUPPLIED ACCESSORIES:</b> Model 070A02 Scope input adaptor (micro 10-32 jack to BNC plug) (1) Model 100-11180-10 IPA Wipe (2) Model 54924-01 Double Sided Base Adhesive Pad (5) Model 54925-01 Single Sided Top Adhesive Pad (5) Model 55739-01 Silicone Fairing (1) Model ACS-21 Calibration of Electret Microphone (1)										
<b>Physical</b> Housing Material Electrical Connector(Output) Cable Type Cable Length Cable Termination Size (Diameter)(Without fairing) Size (Diameter)(With fairing) Size (Height) Weight Weight(without cable)	Stainless Steel Integral Cable 030 Coaxial 5 ft 10-32 Coaxial Plug 0.52 in 1.62 in 0.126 in 0.3 oz 0.03 oz	Stainless Steel Integral Cable 030 Coaxial 1.5 m 10-32 Coaxial Plug 13.2 mm 41.0 mm 3.20 mm 7 gm 0.8 gm	<table border="1"> <tr> <td data-bbox="1134 852 1297 893">Entered: AP</td> <td data-bbox="1297 852 1461 893">Engineer: MJN</td> <td data-bbox="1461 852 1625 893">Sales: MV</td> <td data-bbox="1625 852 1789 893">Approved: MT</td> <td data-bbox="1789 852 1946 893">Spec Number:</td> </tr> <tr> <td data-bbox="1134 893 1297 933">Date: 7/25/2014</td> <td data-bbox="1297 893 1461 933">Date: 7/25/2014</td> <td data-bbox="1461 893 1625 933">Date: 7/25/2014</td> <td data-bbox="1625 893 1789 933">Date: 7/25/2014</td> <td data-bbox="1789 893 1946 933"><b>56068</b></td> </tr> </table>	Entered: AP	Engineer: MJN	Sales: MV	Approved: MT	Spec Number:	Date: 7/25/2014	Date: 7/25/2014	Date: 7/25/2014	Date: 7/25/2014	<b>56068</b>
Entered: AP	Engineer: MJN	Sales: MV	Approved: MT	Spec Number:									
Date: 7/25/2014	Date: 7/25/2014	Date: 7/25/2014	Date: 7/25/2014	<b>56068</b>									
 [4] All specifications are at room temperature unless otherwise specified. In the interest of constant product improvement, we reserve the right to change specifications without notice. ICP® is a registered trademark of PCB Group, Inc.			 3425 Walden Avenue, Depew, NY 14043 <b>Phone: 716-684-0001</b> <b>Fax: 716-684-0987</b> <b>E-Mail: info@pcb.com</b>										

## Repair and Maintenance

PCB guarantees Total Customer Satisfaction through its “Lifetime Warranty Plus” on all Platinum Stock Products sold by PCB and through its limited warranties on all other PCB Stock, Standard and Special products. Due to the sophisticated nature of our sensors and associated instrumentation, **field servicing and repair is not recommended and, if attempted, will void the factory warranty.**

Beyond routine calibration and battery replacements where applicable, our products require no user maintenance. Clean electrical connectors, housings, and mounting surfaces with solutions and techniques that will not harm the material of construction. Observe caution when using liquids near devices that are not hermetically sealed. Such devices should only be wiped with a dampened cloth—never saturated or submerged.

In the event that equipment becomes damaged or ceases to operate, our Application Engineers are here to support your troubleshooting efforts 24 hours a day, 7 days a week. Call or email with model and serial number as well as a brief description of the problem.

## Calibration

Routine calibration of sensors and associated instrumentation is necessary to maintain measurement accuracy. We recommend calibrating on an annual basis, after exposure to any extreme environmental influence, or prior to any critical test.

PCB Piezotronics is an ISO-9001 certified company whose calibration services are accredited by A2LA to ISO/IEC 17025, with full traceability to SI through N.I.S.T. In addition to our standard calibration services, we also offer specialized tests, including: sensitivity at elevated or cryogenic temperatures, phase response, extended high or low frequency response, extended range, leak testing, hydrostatic pressure testing, and others. For more information, contact your local PCB Piezotronics distributor, sales representative, or factory customer service representative.

## Returning Equipment

If factory repair is required, our representatives will provide you with a Return Material Authorization (RMA) number, which we use to reference any information you have already provided and expedite the repair process. This number should be clearly marked on the outside of all returned package(s) and on any packing list(s) accompanying the shipment.

## Contact Information

PCB Piezotronics, Inc.  
3425 Walden Ave.  
Depew, NY14043 USA  
Toll-free: (800) 828-8840  
24-hour SensorLine: (716) 684-0001  
General inquiries: [info@pcb.com](mailto:info@pcb.com)  
Repair inquiries: [rma@pcb.com](mailto:rma@pcb.com)

For a complete list of distributors, global offices and sales representatives, visit our website, [www.pcb.com](http://www.pcb.com).

## Safety Considerations

This product is intended for use by qualified personnel who recognize shock hazards and are familiar with the precautions required to avoid injury. While our equipment is designed with user safety in mind, the protection provided by the equipment may be impaired if equipment is used in a manner not specified by this manual.

Discontinue use and contact our 24-Hour Sensorline if:

- Assistance is needed to safely operate equipment
- Damage is visible or suspected
- Equipment fails or malfunctions

For complete equipment ratings, refer to the enclosed specification sheet for your product.

## Definition of Terms and Symbols

The following symbols may be used in this manual:



### DANGER

Indicates an immediate hazardous situation, which, if not avoided, may result in death or serious injury.

**CAUTION**

Refers to hazards that could damage the instrument.

**NOTE**

Indicates tips, recommendations and important information. The notes simplify processes and contain additional information on particular operating steps.

**The following symbols may be found on the equipment described in this manual:**



This symbol on the unit indicates that high voltage may be present. Use standard safety precautions to avoid personal contact with this voltage.



This symbol on the unit indicates that the user should refer to the operating instructions located in the manual.



This symbol indicates safety, earth ground.



PCB工业监视和测量设备 - 中国RoHS2公布表

PCB Industrial Monitoring and Measuring Equipment - China RoHS 2 Disclosure Table

部件名称	有害物质					
	铅 (Pb)	汞 (Hg)	镉 (Cd)	六价铬 (Cr(VI))	多溴联苯 (PBB)	多溴二苯醚 (PBDE)
住房	0	0	0	0	0	0
PCB板	X	0	0	0	0	0
电气连接器	0	0	0	0	0	0
压电晶体	X	0	0	0	0	0
环氧	0	0	0	0	0	0
铁氟龙	0	0	0	0	0	0
电子	0	0	0	0	0	0
厚膜基板	0	0	X	0	0	0
电线	0	0	0	0	0	0
电缆	X	0	0	0	0	0
塑料	0	0	0	0	0	0
焊接	X	0	0	0	0	0
铜合金/黄铜	X	0	0	0	0	0
本表格依据 SJ/T 11364 的规定编制。						
0：表示该有害物质在该部件所有均质材料中的含量均在 GB/T 26572 规定的限量要求以下。						
X：表示该有害物质至少在该部件的某一均质材料中的含量超出 GB/T 26572 规定的限量要求。						
铅是欧洲RoHS指令2011/65/ EU附件三和附件四目前由于允许的豁免。						

CHINA RoHS COMPLIANCE



Component Name	Hazardous Substances					
	Lead (Pb)	Mercury (Hg)	Cadmium (Cd)	Chromium VI Compounds (Cr(VI))	Polybrominated Biphenyls (PBB)	Polybrominated Diphenyl Ethers (PBDE)
Housing	O	O	O	O	O	O
PCB Board	X	O	O	O	O	O
Electrical Connectors	O	O	O	O	O	O
Piezoelectric Crystals	X	O	O	O	O	O
Epoxy	O	O	O	O	O	O
Teflon	O	O	O	O	O	O
Electronics	O	O	O	O	O	O
Thick Film Substrate	O	O	X	O	O	O
Wires	O	O	O	O	O	O
Cables	X	O	O	O	O	O
Plastic	O	O	O	O	O	O
Solder	X	O	O	O	O	O
Copper Alloy/Brass	X	O	O	O	O	O

This table is prepared in accordance with the provisions of SJ/T 11364.

O: Indicates that said hazardous substance contained in all of the homogeneous materials for this part is below the limit requirement of GB/T 26572.

X: Indicates that said hazardous substance contained in at least one of the homogeneous materials for this part is above the limit requirement of GB/T 26572.

Lead is present due to allowed exemption in Annex III or Annex IV of the European RoHS Directive 2011/65/EU.

72531

PCB Piezotronics Inc. claims proprietary rights in the information disclosed hereon. Neither it nor any reproduction thereof will be disclosed to others without the written consent of PCB Piezotronics Inc.

REVISIONS		
REV	DESCRIPTION	DIN
NR	RELEASED TO DRAFTING	50245

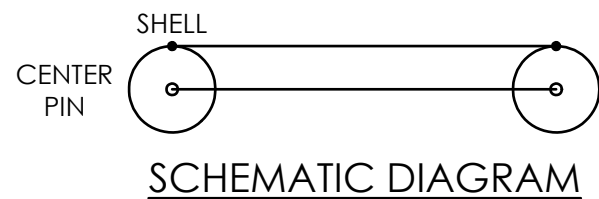
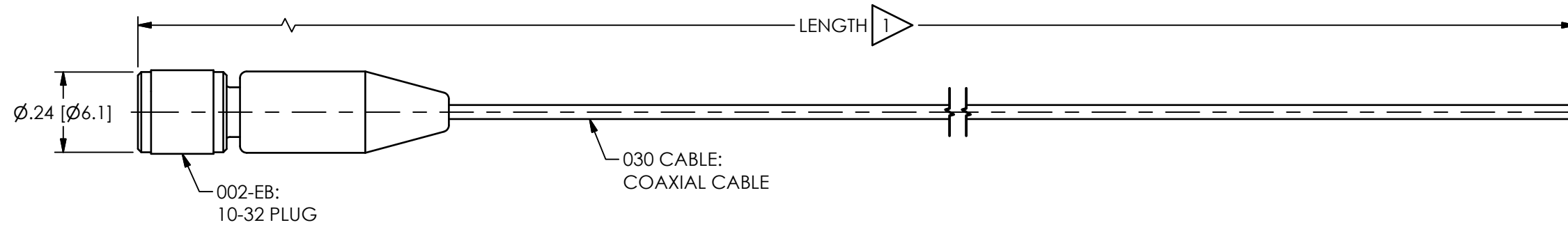

1 LENGTH WILL VARY IN FEET OR METERS DEPENDING ON THE MODEL

CABLE LENGTH TOLERANCE	
LENGTH	TOLERANCE
1"-11"	+1"/-0"
1'-4'	+4"/-0"
5'-99'	+6"/-0"
99'+	+1"/-0"

UNLESS OTHERWISE SPECIFIED TOLERANCES ARE:	
DIMENSIONS IN INCHES	DIMENSIONS IN MILLIMETERS [IN BRACKETS]
DECIMALS XX ±.03 XXX ±.010	DECIMALS X ± 0.8 XX ± 0.25
ANGLES ± 2 DEGREES	ANGLES ± 2 DEGREES
FILLETS AND RADII .003 - .005	FILLETS AND RADII 0.07 - 0.13

DRAWN	CHECKED		ENGINEER		
	JDM	1/28/20	JDM	1/28/20	BAM
TITLE					
OUTLINE DRAWING 030EBBZ SERIES COAXIAL CABLE W/ BNC PLUG					

**PCB PIEZOTRONICS™**  
 3425 WALDEN AVE. DEPEW, NY 14043  
 (716) 684-0001 E-MAIL: sales@pcb.com

CODE IDENT. NO. 52681	DWG. NO. <b>72531</b>
SCALE: 2.5X	SHEET 1 OF 1



**Model 130B40**

**ICP® ELECTRET SURFACE MICROPHONE**

**Installation and Operating Manual**

**For assistance with the operation of this product,  
contact PCB Piezotronics, Inc.**

**Toll-free: 800-828-8840  
24-hour SensorLine: 716-684-0001  
Fax: 716-684-0987  
E-mail: [info@pcb.com](mailto:info@pcb.com)  
Web: [www.pcb.com](http://www.pcb.com)**



## Repair and Maintenance

PCB guarantees Total Customer Satisfaction through its “Lifetime Warranty Plus” on all Platinum Stock Products sold by PCB and through its limited warranties on all other PCB Stock, Standard and Special products. Due to the sophisticated nature of our sensors and associated instrumentation, **field servicing and repair is not recommended and, if attempted, will void the factory warranty.**

Beyond routine calibration and battery replacements where applicable, our products require no user maintenance. Clean electrical connectors, housings, and mounting surfaces with solutions and techniques that will not harm the material of construction. Observe caution when using liquids near devices that are not hermetically sealed. Such devices should only be wiped with a dampened cloth—never saturated or submerged.

In the event that equipment becomes damaged or ceases to operate, our Application Engineers are here to support your troubleshooting efforts 24 hours a day, 7 days a week. Call or email with model and serial number as well as a brief description of the problem.

## Calibration

Routine calibration of sensors and associated instrumentation is necessary to maintain measurement accuracy. We recommend calibrating on an annual basis, after exposure to any extreme environmental influence, or prior to any critical test.

PCB Piezotronics is an ISO-9001 certified company whose calibration services are accredited by A2LA to ISO/IEC 17025, with full traceability to SI through N.I.S.T. In addition to our standard calibration services, we also offer specialized tests, including: sensitivity at elevated or cryogenic temperatures, phase response, extended high or low frequency response, extended range, leak testing, hydrostatic pressure testing, and others. For more information, contact your local PCB Piezotronics distributor, sales representative, or factory customer service representative.

## Returning Equipment

If factory repair is required, our representatives will provide you with a Return Material Authorization (RMA) number, which we use to reference any information you have already provided and expedite the repair process. This number should be clearly marked on the outside of all returned package(s) and on any packing list(s) accompanying the shipment.

## Contact Information

PCB Piezotronics, Inc.  
3425 Walden Ave.  
Depew, NY14043 USA  
Toll-free: (800) 828-8840  
24-hour SensorLine: (716) 684-0001  
General inquiries: [info@pcb.com](mailto:info@pcb.com)  
Repair inquiries: [rma@pcb.com](mailto:rma@pcb.com)

For a complete list of distributors, global offices and sales representatives, visit our website, [www.pcb.com](http://www.pcb.com).

## Safety Considerations

This product is intended for use by qualified personnel who recognize shock hazards and are familiar with the precautions required to avoid injury. While our equipment is designed with user safety in mind, the protection provided by the equipment may be impaired if equipment is used in a manner not specified by this manual.

Discontinue use and contact our 24-Hour Sensorline if:

- Assistance is needed to safely operate equipment
- Damage is visible or suspected
- Equipment fails or malfunctions

For complete equipment ratings, refer to the enclosed specification sheet for your product.

## Definition of Terms and Symbols

The following symbols may be used in this manual:



### DANGER

Indicates an immediate hazardous situation, which, if not avoided, may result in death or serious injury.

**CAUTION**

Refers to hazards that could damage the instrument.

**NOTE**

Indicates tips, recommendations and important information. The notes simplify processes and contain additional information on particular operating steps.

**The following symbols may be found on the equipment described in this manual:**



This symbol on the unit indicates that high voltage may be present. Use standard safety precautions to avoid personal contact with this voltage.



This symbol on the unit indicates that the user should refer to the operating instructions located in the manual.



This symbol indicates safety, earth ground.



PCB工业监视和测量设备 - 中国RoHS2公布表

PCB Industrial Monitoring and Measuring Equipment - China RoHS 2 Disclosure Table

部件名称	有害物质					
	铅 (Pb)	汞 (Hg)	镉 (Cd)	六价铬 (Cr(VI))	多溴联苯 (PBB)	多溴二苯醚 (PBDE)
住房	0	0	0	0	0	0
PCB板	X	0	0	0	0	0
电气连接器	0	0	0	0	0	0
压电晶体	X	0	0	0	0	0
环氧	0	0	0	0	0	0
铁氟龙	0	0	0	0	0	0
电子	0	0	0	0	0	0
厚膜基板	0	0	X	0	0	0
电线	0	0	0	0	0	0
电缆	X	0	0	0	0	0
塑料	0	0	0	0	0	0
焊接	X	0	0	0	0	0
铜合金/黄铜	X	0	0	0	0	0
本表格依据 SJ/T 11364 的规定编制。						
0：表示该有害物质在该部件所有均质材料中的含量均在 GB/T 26572 规定的限量要求以下。						
X：表示该有害物质至少在该部件的某一均质材料中的含量超出 GB/T 26572 规定的限量要求。						
铅是欧洲RoHS指令2011/65/ EU附件三和附件四目前由于允许的豁免。						

CHINA RoHS COMPLIANCE

Component Name	Hazardous Substances					
	Lead (Pb)	Mercury (Hg)	Cadmium (Cd)	Chromium VI Compounds (Cr(VI))	Polybrominated Biphenyls (PBB)	Polybrominated Diphenyl Ethers (PBDE)
Housing	O	O	O	O	O	O
PCB Board	X	O	O	O	O	O
Electrical Connectors	O	O	O	O	O	O
Piezoelectric Crystals	X	O	O	O	O	O
Epoxy	O	O	O	O	O	O
Teflon	O	O	O	O	O	O
Electronics	O	O	O	O	O	O
Thick Film Substrate	O	O	X	O	O	O
Wires	O	O	O	O	O	O
Cables	X	O	O	O	O	O
Plastic	O	O	O	O	O	O
Solder	X	O	O	O	O	O
Copper Alloy/Brass	X	O	O	O	O	O

This table is prepared in accordance with the provisions of SJ/T 11364.

O: Indicates that said hazardous substance contained in all of the homogeneous materials for this part is below the limit requirement of GB/T 26572.

X: Indicates that said hazardous substance contained in at least one of the homogeneous materials for this part is above the limit requirement of GB/T 26572.

Lead is present due to allowed exemption in Annex III or Annex IV of the European RoHS Directive 2011/65/EU.

2

1

PCB Piezotronics Inc. claims proprietary rights in the information disclosed hereon. Neither it nor any reproduction thereof will be disclosed to others without the written consent of PCB Piezotronics Inc.

REVISIONS

REV	DESCRIPTION	DIN
A	REMOVED "PRELIMINARY"	42104

56070

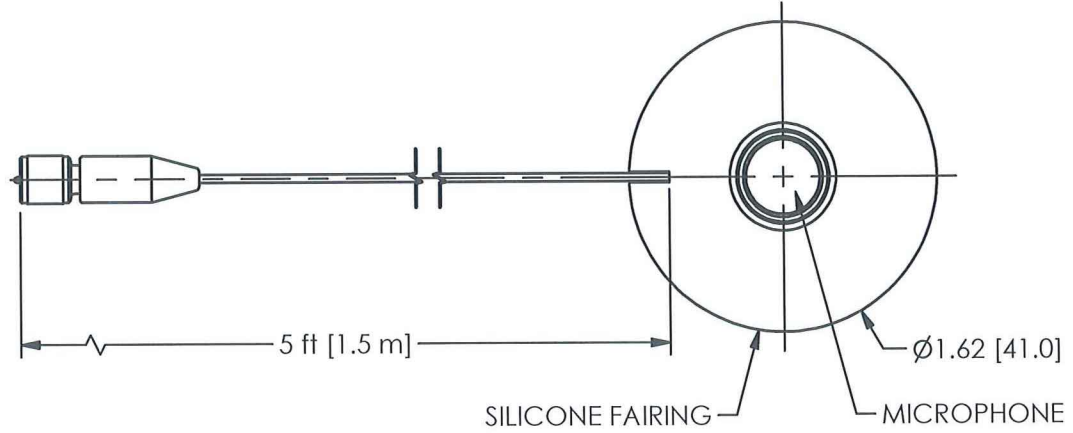

UNLESS OTHERWISE SPECIFIED TOLERANCES ARE:

DIMENSIONS IN INCHES	DIMENSIONS IN MILLIMETERS [ IN BRACKETS ]
DECIMALS XX ±.03 XXX ±.010	DECIMALS X ± 0.8 XX ± 0.25
ANGLES ± 2 DEGREES	ANGLES ± 2 DEGREES

FILLETS AND RADII  
.003 - .005

FILLETS AND RADII  
0.07 - 0.13

DRAWN

CHECKED

ENGINEER

JDM	10/11/13	<i>JDM</i>	10/11/13	MJN	10/11/13
-----	----------	------------	----------	-----	----------

TITLE

OUTLINE DRAWING  
MODEL 130B40  
SURFACE MICROPHONE



3425 WALDEN AVE. DEPEW, NY 14043  
(716) 684-0001 E-MAIL: sales@pcb.com

CODE IDENT. NO.  
52681

DWG. NO.

56070

SCALE: FULL SHEET 1 OF 1

2

1