



Model 699B07

Portable Vibration Calibrator with 5-10k Hz frequency range adjustable amplitude ranges (acceleration, velocity, displacement). Calibrates all types of vibration transducers with input. LCD readout in English or metric units. Memory & USB storage

Installation and Operating Manual

**For assistance with the operation of this product,
contact the PCB Piezotronics, Inc.**

**Toll-free: 800-959-4464
24-hour SensorLine: 716-684-0001
Fax: 716-684-3823
E-mail: imi@pcb.com
Web: www.imi-sensors.com**



Repair and Maintenance

PCB guarantees Total Customer Satisfaction through its “Lifetime Warranty Plus” on all Platinum Stock Products sold by PCB and through its limited warranties on all other PCB Stock, Standard and Special products. Due to the sophisticated nature of our sensors and associated instrumentation, **field servicing and repair is not recommended and, if attempted, will void the factory warranty.**

Beyond routine calibration and battery replacements where applicable, our products require no user maintenance. Clean electrical connectors, housings, and mounting surfaces with solutions and techniques that will not harm the material of construction. Observe caution when using liquids near devices that are not hermetically sealed. Such devices should only be wiped with a dampened cloth—never saturated or submerged.

In the event that equipment becomes damaged or ceases to operate, our Application Engineers are here to support your troubleshooting efforts 24 hours a day, 7 days a week. Call or email with model and serial number as well as a brief description of the problem.

Calibration

Routine calibration of sensors and associated instrumentation is necessary to maintain measurement accuracy. We recommend calibrating on an annual basis, after exposure to any extreme environmental influence, or prior to any critical test.

PCB Piezotronics is an ISO-9001 certified company whose calibration services are accredited by A2LA to ISO/IEC 17025, with full traceability to SI through N.I.S.T. In addition to our standard calibration services, we also offer specialized tests, including: sensitivity at elevated or cryogenic temperatures, phase response, extended high or low frequency response, extended range, leak testing, hydrostatic pressure testing, and others. For more information, contact your local PCB Piezotronics distributor, sales representative, or factory customer service representative.

Returning Equipment

If factory repair is required, our representatives will provide you with a Return Material Authorization (RMA) number, which we use to reference any information you have already provided and expedite the repair process. This number should be clearly marked on the outside of all returned package(s) and on any packing list(s) accompanying the shipment.

Contact Information

PCB Piezotronics, Inc.
3425 Walden Ave.
Depew, NY14043 USA
Toll-free: (800) 828-8840
24-hour SensorLine: (716) 684-0001
General inquiries: info@pcb.com
Repair inquiries: rma@pcb.com

For a complete list of distributors, global offices and sales representatives, visit our website, www.pcb.com.

Safety Considerations

This product is intended for use by qualified personnel who recognize shock hazards and are familiar with the precautions required to avoid injury. While our equipment is designed with user safety in mind, the protection provided by the equipment may be impaired if equipment is used in a manner not specified by this manual.

Discontinue use and contact our 24-Hour Sensorline if:

- Assistance is needed to safely operate equipment
- Damage is visible or suspected
- Equipment fails or malfunctions

For complete equipment ratings, refer to the enclosed specification sheet for your product.

Definition of Terms and Symbols

The following symbols may be used in this manual:



DANGER

Indicates an immediate hazardous situation, which, if not avoided, may result in death or serious injury.

**CAUTION**

Refers to hazards that could damage the instrument.

**NOTE**

Indicates tips, recommendations and important information. The notes simplify processes and contain additional information on particular operating steps.

The following symbols may be found on the equipment described in this manual:



This symbol on the unit indicates that high voltage may be present. Use standard safety precautions to avoid personal contact with this voltage.



This symbol on the unit indicates that the user should refer to the operating instructions located in the manual.



This symbol indicates safety, earth ground.



PCB工业监视和测量设备 - 中国RoHS2公布表

PCB Industrial Monitoring and Measuring Equipment - China RoHS 2 Disclosure Table

部件名称	有害物质					
	铅 (Pb)	汞 (Hg)	镉 (Cd)	六价铬 (Cr(VI))	多溴联苯 (PBB)	多溴二苯醚 (PBDE)
住房	0	0	0	0	0	0
PCB板	X	0	0	0	0	0
电气连接器	0	0	0	0	0	0
压电晶体	X	0	0	0	0	0
环氧	0	0	0	0	0	0
铁氟龙	0	0	0	0	0	0
电子	0	0	0	0	0	0
厚膜基板	0	0	X	0	0	0
电线	0	0	0	0	0	0
电缆	X	0	0	0	0	0
塑料	0	0	0	0	0	0
焊接	X	0	0	0	0	0
铜合金/黄铜	X	0	0	0	0	0
本表格依据 SJ/T 11364 的规定编制。						
0：表示该有害物质在该部件所有均质材料中的含量均在 GB/T 26572 规定的限量要求以下。						
X：表示该有害物质至少在该部件的某一均质材料中的含量超出 GB/T 26572 规定的限量要求。						
铅是欧洲RoHS指令2011/65/ EU附件三和附件四目前由于允许的豁免。						

CHINA RoHS COMPLIANCE

Component Name	Hazardous Substances					
	Lead (Pb)	Mercury (Hg)	Cadmium (Cd)	Chromium VI Compounds (Cr(VI))	Polybrominated Biphenyls (PBB)	Polybrominated Diphenyl Ethers (PBDE)
Housing	O	O	O	O	O	O
PCB Board	X	O	O	O	O	O
Electrical Connectors	O	O	O	O	O	O
Piezoelectric Crystals	X	O	O	O	O	O
Epoxy	O	O	O	O	O	O
Teflon	O	O	O	O	O	O
Electronics	O	O	O	O	O	O
Thick Film Substrate	O	O	X	O	O	O
Wires	O	O	O	O	O	O
Cables	X	O	O	O	O	O
Plastic	O	O	O	O	O	O
Solder	X	O	O	O	O	O
Copper Alloy/Brass	X	O	O	O	O	O

This table is prepared in accordance with the provisions of SJ/T 11364.

O: Indicates that said hazardous substance contained in all of the homogeneous materials for this part is below the limit requirement of GB/T 26572.

X: Indicates that said hazardous substance contained in at least one of the homogeneous materials for this part is above the limit requirement of GB/T 26572.

Lead is present due to allowed exemption in Annex III or Annex IV of the European RoHS Directive 2011/65/EU.

VIBRATION ANALYZER / METER CALIBRATION

PRODUCT MANUAL | MODEL 699B07 REPORT GENERATION WORKBOOK

Note: This manual only provides instructions for the calibration of portable vibration analyzers. The Report Generation Workbook has many other uses such as the calibration of: accelerometers, proximity probes, and 4-20 mA vibration transmitters. Instruction regarding how to test other vibration instrumentation is found in the supplied Portable Vibration Calibrator manual.

VIBRATION ANALYZER / METER CALIBRATION

PRODUCT SUPPORT

For answers to questions about this product, consult this manual or the accessory manual. For additional product support, contact PCB Piezotronics at 800.828.8840. If it is more convenient, fax your questions or comments to PCB Piezotronics at 716.684.0987 or email our technical staff at info@pcb.com.

WARRANTY

PCB Piezotronics, Inc. Series 699B Portable Vibration Calibrator & Shaker Table products are warranted against defective materials and workmanship for TWO YEARS from the date of shipment, unless otherwise specified. Damage to equipment caused by incorrect power, misapplication, or procedures inconsistent with this manual are not covered by warranty. If there are any questions concerning the intended application of the product, contact an Applications Engineer. Batteries and other expendable accessory hardware items are excluded.

COPYRIGHT

Copyright ©2019 PCB Piezotronics, Inc. This manual is copyrighted with all rights reserved. The manual may not be copied in whole or in part for any use without prior written consent of PCB Piezotronics, Inc.

DISCLAIMER

The following paragraph does not apply in any state or country where such statements are not agreeable with local law:

PCB Piezotronics, Inc. provides this publication “as is” without warranty of any kind, express or implied, including but not limited to, the implied warranties of merchantability or fitness for a particular purpose. This document is subject to change without notice, and should not be construed as a commitment or representation by PCB Piezotronics, Inc.

This publication may contain inaccuracies or typographical errors. PCB Piezotronics, Inc. will periodically update the material for inclusion in new editions. Changes and improvements to the product described in this manual may be made at any time.

TRADEMARKS

ICP® is a registered trademark of PCB Piezotronics, Inc.

Microsoft Excel® is a registered trademark of Microsoft Corporation in the United States and/or other countries.



3425 Walden Ave.
Depew, NY, 14043-2495
Phone: 716.684.0002
FAX: 716.684.0987
www.pcb.com
info@pcb.com

TABLE OF CONTENTS

- 1. INTRODUCTION..... 4

- 2. VIBRATION ANALYZER CERTIFICATE..... 5
 - 2.1 CREATING A VIBRATION ANALYZER CERTIFICATE..... 5
 - 2.2 EXAMPLES OF VIBRATION ANALYZER VALIDATION LINEARITY & FREQUENCY RESPONSE CALIBRATION CERTIFICATES 9

- 3. VIBRATION ANALYZER TESTING..... 10
 - 3.1 TEST SET-UP..... 10
 - 3.2 IMAGES OF RAW LINEARITY TEST DATA 11
 - 3.3 ENTERING LINEARITY TEST DATA INTO THE PVC REPORT GENERATION WORKBOOK..... 14
 - 3.4 IMAGES OF RAW FREQUENCY RESPONSE TEST DATA..... 15
 - 3.5 ENTERING FREQUENCY RESPONSE TEST DATA INTO THE PVC REPORT GENERATION WORKBOOK..... 19

- 4. PRODUCING THE FINAL CALIBRATION CERTIFICATES 20
 - 4.1 LINEARITY TEST 20
 - 4.2 FREQUENCY RESPONSE TEST 21

1. INTRODUCTION

PCB Piezotronics' Portable Vibration Calibrator (PVC) can be used to validate any type of vibration analyzer or vibration meter. The PVC Report Generation workbook ver.3.1.0 includes a "**Vib Analyzer Data**" tab (shown below) that is used to create Linearity and Frequency Test Certificates for Vibration Analyzers. This Microsoft Excel® Macro-Enabled workbook provides an intuitive interface that allows users to create and print a calibration certificates in a few minutes.

~ Vibration Analyzer Certification ~

Analyzer/Meter Information *

Manufacturer:

Model Number:

Serial Number:

Cal. Tech:

Cal. date:

Cal. due:

Analyzer Settings *

Analyzer mode:

Frequency Max:

Frequency Min:

Frequency Unit:

Lines of Resolution:

Averaging Points:

Window Type:

Analyzer Sensor Input Sensitivity:

Unit:

Test Equipment *									
Description	Model Number	Serial Number	Cal date	Cal. Sensitivity @ 100Hz	Unit	Meas. Sensitivity @ 100Hz	Unit	% Tolerance	% Deviation
PVC					mV/g		mV/g	3.00%	
Sensor					mV/g		mV/g	5.00%	
DMM									

No.	Known Value		Measured Value		% Deviation	
	Amplitude	Frequency	Amplitude	Frequency	Amplitude	Frequency
1						
2						
3						
4						
5						
6						
7						
8						
9						
10						
11						
12						
13						
14						
15						

Test *

Test Frequency:

Freq Unit:

Test Amplitude:

Amp. Unit:

Due to shaker limitation, it may not be possible to maintain the same amplitude at all speed or the same frequency at all amplitude. If this occurs, calibration is still valid, but it is best practice to document any points where excitation could not meet requirement in the notes field of the certificate.

Figure 1: Vib Analyzer Data tab

2. VIBRATION ANALYZER CERTIFICATE

2.1 Creating a Vibration Analyzer Certificate

Using PCB Piezotronics' Portable Vibration Calibrator and supplied Report Generation Workbook, technicians can create calibration reports for their portable vibration analyzers by mechanical vibration simulation rather than voltage injection. A mechanical simulation allows users to test the entire measurement chain: sensor, cabling, and analyzer.

Calibration is performed by comparing a known source of vibration at different amplitudes and frequencies to the analyzer or meter reading. PCB Piezotronics' Portable Vibration Calibrator (NIST traceable, ISO 16063-21 and 17025-compliant) provides variable vibration amplitudes with a very wide frequency range. With this ideology, the analyzer and its sensing elements are validated together as a system. For route-based predictive maintenance where one sensor is magnetically mounted on many machines at many points, PCB recommends performing a complete frequency response test of the accelerometer. Its accuracy is important at many frequencies. Test to maximum frequency of interest (Fmax) on the vibration analyzer. If high frequency bearing fault detection methodologies are in use, test the sensor to the highest possible bearing defect frequency.

Tip: Magnetically mounting sensors greatly reduces high frequency response. A ferrous magnet target, mounting pad, is included with the Portable Vibration Calibrator. One can install this pad on the shaker and mount accelerometers magnetically. Always rock the sensor in place as one would on the machine. Test the accelerometer to the maximum frequency of interest (Fmax) on the analyzer to see if response is amplified at relevant high frequencies.

To create a NIST traceable calibration certificate for a vibration analyzer or meter, the following items are required:

- PVC Report Generation Workbook ver.3.1.0 (Released in March 2019) or later
- Calibrated Portable Vibration Calibrator
- Calibrated voltmeter or oscilloscope
- BNC male to BNC male cable (e.g. PCB Series: 012A, 002D and 003D)
- BNC female to double banana plug (Pomona Model 1269)

Step 1 Start by filling the vibration Analyzer/Meter information and Settings

Analyzer/Meter Information *	Analyzer Settings *
Manufacturer: <input type="text"/>	Analyzer mode: <input type="text"/>
Model Number: <input type="text"/>	Frequency Max: <input type="text"/>
Serial Number: <input type="text"/>	Frequency Min: <input type="text"/>
Cal. Tech: <input type="text"/>	Frequency Unit: <input type="text"/>
Cal. date: <input type="text"/>	Lines of Resolution: <input type="text"/>
Cal. due: <input type="text"/>	Averaging Points: <input type="text"/>
	Window Type: <input type="text"/>
	Analyzer Sensor Input Sensitivity: <input type="text"/>
	Unit: <input type="text"/>

- Analyzer mode: **Spectra, Overall, or Time waveform**

Tip: Some vibration data associated with a certain frequency appears in (leaks into) adjacent frequencies; this is called leakage error. Non-periodic signals or transients that are not properly windowed cause leakage errors. In other words, a leakage error occurs because of a truncation of the waveform. Proper windows and selection of sampling frequency can reduce or eliminate the leakage effect. Different window types apply different shaping functions to the vibration waveform signal before computing the spectrum. For example, **Hanning window** (window factor 1.5) is the most common window used in vibration analysis and normal analyzer operation. It smooths end effects and reduces leakage in the spectrum. However, it reduces the amplitude by $\leq 16\%$. **Uniform window** (aka Rectangular or No Window) does not apply any shaping and is subject to leakage and amplitude errors. It reduces the amplitude by $\leq 36\%$, yet is very effective with transient vibration and used when there is more concern with frequency than amplitude. For more details about window type, please consult your vibration analyzer user manual.

Although, users can choose between the below four window types, that does not change any measurement or calculations in the workbook. This is just to document your on-site analyzer settings.

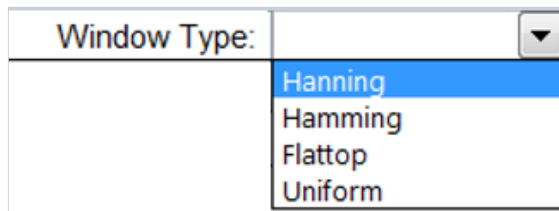

- Analyzer Sensor Input *Sensitivity* and *Unit*: entering the accurate sensor sensitivity in the analyzer is a key element of your route-based measurements. You should use the Portable Vibration Calibrator to measure the sensitivity at the reference frequency (100 Hz or 159.2 Hz) and document this value in the analyzer and workbook. To learn more, visit our Field Calibration of the Emerson™ CSI 2130 Vibration Analyzer video at <https://www.youtube.com/watch?v=WFe3O6XEMwU>.

Step 2 Fill in your Test Equipment details in the blue cells

Test Equipment *									
Description	Model Number	Serial Number	Cal date	Cal. Sensitivity @ 100Hz	Unit	Meas. Sensitivity @ 100Hz	Unit	% Tolerance	% Deviation
PVC					mV/g		mV/g	3.00%	
Sensor					mV/g		mV/g	5.00%	
DMM									

- It is good practice to test the vibration calibrator for any reference accelerometer sensitivity drifts before validating your vibration analyzer. PCB Piezotronics' PVC is controlled (*Closed-Loop*) by an internal shear mode quartz reference accelerometer. The voltage output of the reference accelerometer can be monitored through the available **MONITOR REFERENCE OUT BNC** output by connecting it to a readout device (e.g. voltmeter or oscilloscope) in real time.

The calibration sensitivity at 100 Hz can be found on the original A2LA-Accredited calibration certificate supplied by PCB Piezotronics.

To measure the sensitivity of the Portable Vibration Calibrator:

- Set the PVC to 1.00 g RMS at 100 Hz
- Connect the DMM to the **MONITOR REFERENCE OUT** and measure mV AC
- Record the Measured Sensitivity at 100 Hz in cell **I16**

The measured sensitivity of the PVC reference accelerometer should be within $\pm 3\%$ of the original calibrated sensitivity. Otherwise, please consider sending your Portable Calibrator for re-calibration using service code ICS-41.

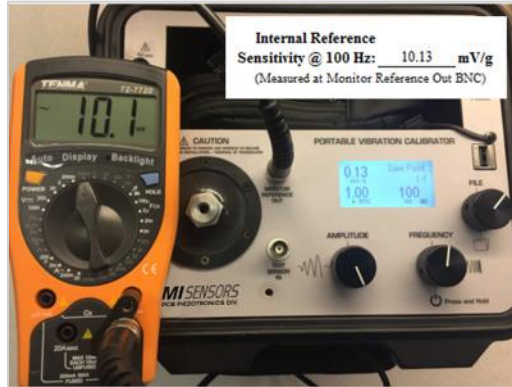

Figure 2: DMM connected to Monitor Reference out on a 699B07

- **Sensor Information:** this information pertains to the sensor used with the analyzer to collect route vibration data. The % tolerance should be changed as advised by the sensor’s manufacturer. It is $\pm 5\%$ by default.
 - Example: The Emerson™ A0760 Accelerometer typically supplied with their portable vibration analyzers has a sensitivity of 100 mV/g with +/- 5% tolerance at 100 Hz. Users should test this sensor by shaking at 1 g RMS at 100 Hz before calibrating their analyzer. If the sensor is found to be out of tolerance this error will manifest itself in the vibration analyzer readings. Users can either adjust the input sensitivity of the vibration analyzer to compensate for the error or acquire a new accelerometer.

Step 3 Fill in the known and measured values:

The known values could be entered manually or imported from the Vib Analyzer CalRoute “.pvc” file by clicking on the **Load Test Route** button. For more information about CALROUTE, please consult the Portable Vibration Calibrator User Manual.

**Load
Test Route**

No.	Known Value		Measured Value		% Deviation	
	Amplitude	Frequency	Amplitude	Frequency	Amplitude	Frequency
1						
2						
3						
4						
5						
6						
7						
8						
9						
10						
11						
12						
13						
14						
15						

- Test frequency in cell **K25** must be filled in when creating a **Linearity Test Certificate**.
- Test amplitude in cell **K28** must be filled in when creating a **Frequency Test Certificate**.

- When loading a test route, the test frequency and amplitude values and units get automatically filled in cells K25 and K28 respectively.

The image shows a form titled "Test *". It contains four input fields arranged in two pairs. The first pair consists of "Test Frequency:" followed by a blue-filled text box, and "Freq Unit:" followed by a dropdown menu with a downward arrow. The second pair consists of "Test Amplitude:" followed by a blue-filled text box, and "Amp. Unit:" followed by a dropdown menu with a downward arrow.

Step 4 Print Calibration Certificate by clicking on the appropriate test certification button.

Print Linearity Test Certification

Use this button to print Amplitude Linearity Certificates.

Print Frequency Test Certification

Use this button to print Frequency Response Certificates.

2.2 Examples of Vibration Analyzer Validation Linearity & Frequency Response Calibration Certificates

Linearity Test Certificate:

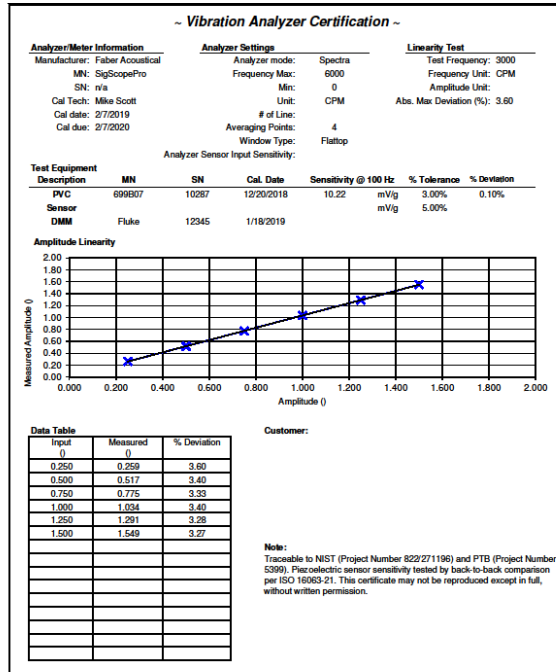

Frequency Test Certificate:

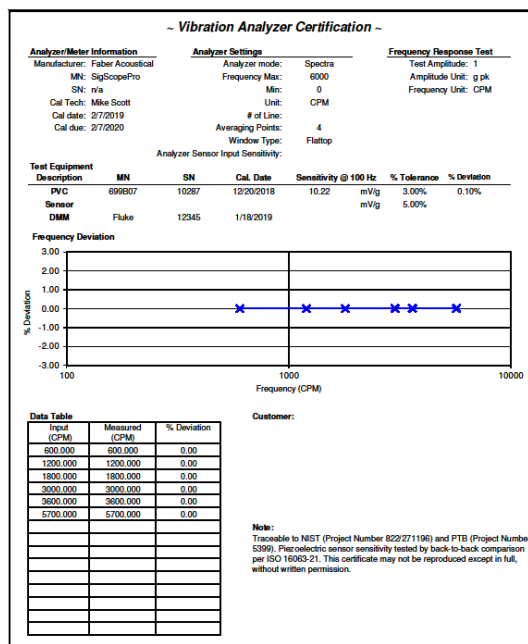

3. VIBRATION ANALYZER TESTING

3.1 Test Set-Up

The following example utilizes PCB Piezotronics Model 633A01 Digital Accelerometer connected to an Apple® iPhone® running Signal Scope Pro application created by Faber Acoustical. The Faber Acoustical app is available in the app store. The Digital Accelerometer allows users to turn their phone, tablet, or laptop into a portable vibration analyzer.



Figure 3: Test Setup – Model 633A01 is mounted onto Model 699B07 Portable Vibration Calibrator; the output of 633A01 is measured using the Signal Scope Pro application by Faber Acoustical

The 633A01 Digital Accelerometer is mounted to the 699B07 Portable Vibration Calibrator via its ¼-28 stud. The sensor's integral cable is connected to the Apple® iPhone® input. The Apple® iPhone® is running Signal Scope Pro by Faber Acoustical. The known vibration values are shown on the screen of the 699B07. "Bias Fault" appears at top left of the 699B07's screen because we have ICP® Power turned on within the 699B07 but do not have an ICP® accelerometer connected to the Test Sensor Input BNC. For the purpose of this test the "Bias Fault" is not a concern. However, if "Bias Fault" were to appear when testing an ICP® accelerometer it would indicate that the sensor under test is dead or its cable has shorted.

3.2 Images of Raw Linearity Test Data

MODEL 699B07 LINEARITY TEST	
Known Vibration Mechanically Generated by 699B07	Measured Vibration Using Signal Scope Pro FFT & 633A01 Digital Accelerometer



Test Point 1: Known Vibration = 0.25 g pk at 3000 CPM

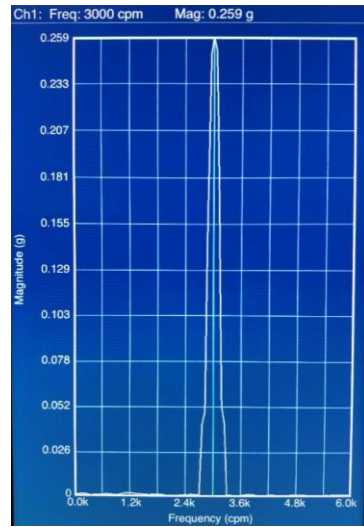

Test Point 1: Measured Vibration = 0.259 g pk at 3000 CPM



Test Point 2: Known Vibration = 0.50 g pk at 3000 CPM

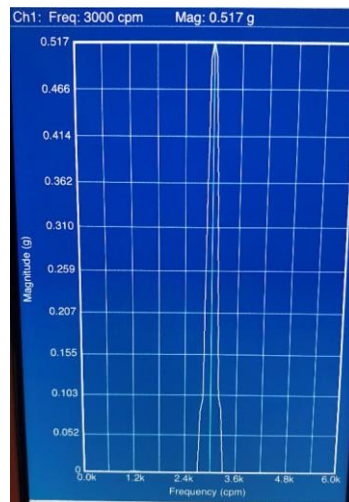

Test Point 2: Measured Vibration = 0.517 g pk at 3000 CPM



Test Point 3: Known Vibration = 0.75 g pk at 3000 CPM

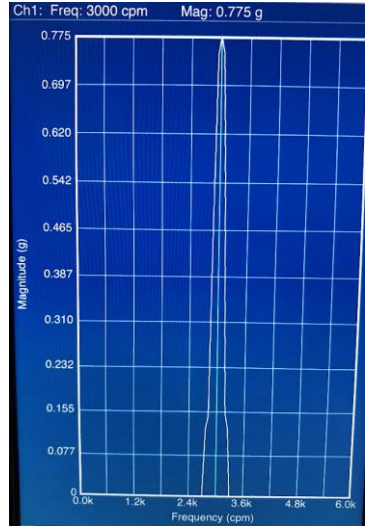

Test Point 3: Measured Vibration = 0.775 g pk at 3000 CPM



Test Point 4: Known Vibration = 1.00 g pk at 3000 CPM

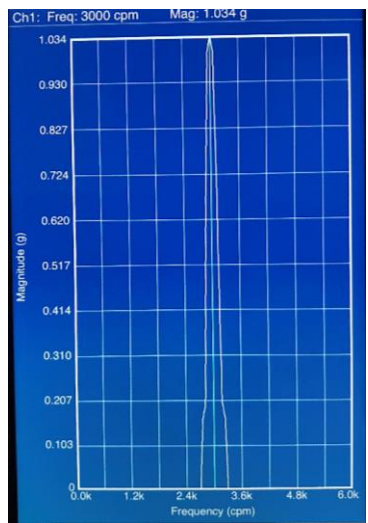

Test Point 4: Measured Vibration = 1.034 g pk at 3000 CPM

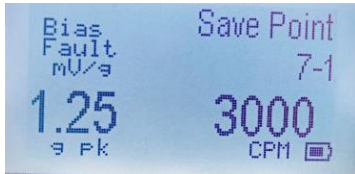

Test Point 5: Known Vibration = 1.25 g pk at 3000 CPM

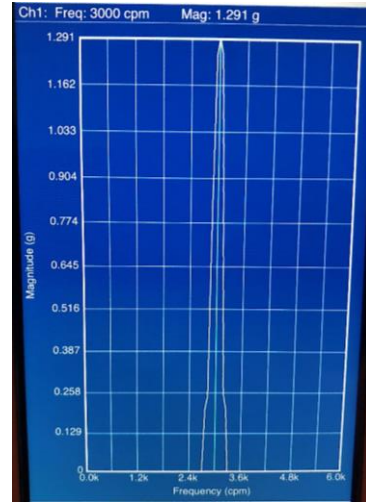

Test Point 5: Measured Vibration = 1.291 g pk at 3000 CPM



Test Point 6: Known Vibration = 1.50 g pk at 3000 CPM

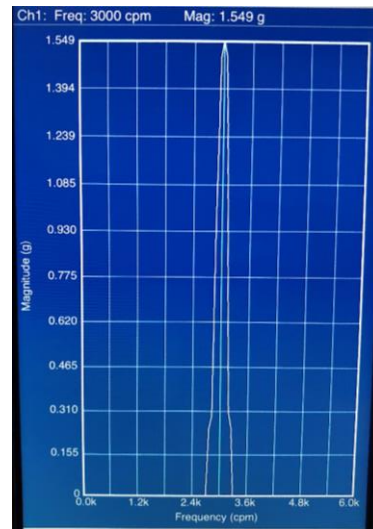

Test Point 6: Measured Vibration = 1.549 g pk at 3000 CPM

3.3 Entering Linearity Test Data into the PVC Report Generation Workbook

~ Vibration Analyzer Certification ~

Analyzer/Meter Information *

Manufacturer:	Faber Acoustical
Model Number:	SigScopePro
Serial Number:	n/a
Cal. Tech:	Mike Scott
Cal. date:	2/7/2019
Cal. due:	2/7/2020

Analyzer Settings *

Analyzer mode:	Spectra
Frequency Max:	6000
Frequency Min:	0
Frequency Unit:	CPM
Lines of Resolution:	
Averaging Points:	4
Window Type:	Flattop
Analyzer Sensor Input Sensitivity:	
Unit:	

Print Linearity Test Certification

Print Frequency Test Certification

Load Test Route

Reset Form

Test Equipment *

Description	Model Number	Serial Number	Cal date	Cal. Sensitivity @ 100Hz	Unit	Meas. Sensitivity @ 100Hz	Unit	% Tolerance	% Deviation
PVC	699B07	10287	12/20/2018	10.22	mV/g	10.23	mV/g	3.00%	0.10%
Sensor					mV/g		mV/g	5.00%	
DMM	Fluke	12345	1/18/2019						

No.	Known Value		Measured Value		% Deviation	
	Amplitude	Frequency	Amplitude	Frequency	Amplitude	Frequency
1	0.250	3000	0.259	3000	3.60	0.00
2	0.500	3000	0.517	3000	3.40	0.00
3	0.750	3000	0.775	3000	3.33	0.00
4	1.000	3000	1.034	3000	3.40	0.00
5	1.250	3000	1.291	3000	3.28	0.00
6	1.500	3000	1.549	3000	3.27	0.00
7						
8						
9						
10						
11						
12						
13						
14						
15						

Test Frequency:	3000
Freq Unit:	CPM
Test Amplitude:	
Amp. Unit:	g pk

Due to shaker limitation, it may not be possible to maintain the same amplitude at all speed or the same frequency at all amplitude. If this occurs, calibration is still valid, but it is best practice to document any points where excitation could not meet requirement in the notes field of the certificate.

It is important to note:

- The Analyzer/Meter information including model and serial number
- Any applicable analyzer settings. For example, the Frequency Max, Lines of Resolution, Averaging and Window Type can all have an effect on accuracy.
- For this linearity test we used a constant frequency of 3000 CPM. This needs to be noted in the Test block on the right side of the form next to the raw data.
- The known values are noted from the screen of the Portable Vibration Calibrator.
- The measured values come from our FFT analyzer in the Signal Scope Pro application.
 - Note, you can see that our amplitude deviation was consistently 3.27% to 3.60% high. There is no way to adjust the settings in the Signal Scope Pro application to reduce this error. However other vibration analyzers do allow users to change the input sensitivity setting which can correct consistent error such as the example shown.

Within the supplied Microsoft® Excel PVC Report Generation Workbook the raw data for the frequency response test is entered as shown below.

3.4 Images of Raw Frequency Response Test Data

MODEL 699B07 FREQUENCY RESPONSE TEST	
Known Vibration Mechanically Generated by 699B07	Measured Vibration Using Signal Scope Pro FFT & 633A01 Digital Accelerometer



Test Point 1: Known Vibration = 0.80 g pk at 600 CPM

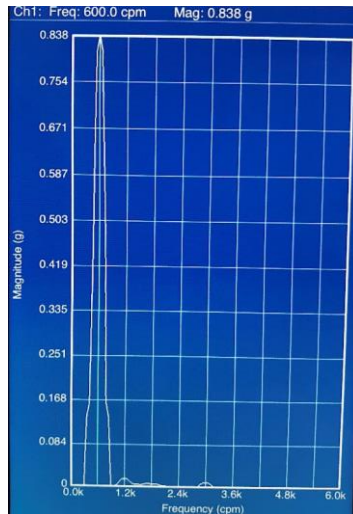

Test Point 1: Measured Vibration = 0.838 g pk at 600 CPM



Test Point 2: Known Vibration = 1.00 g pk at 1200 CPM

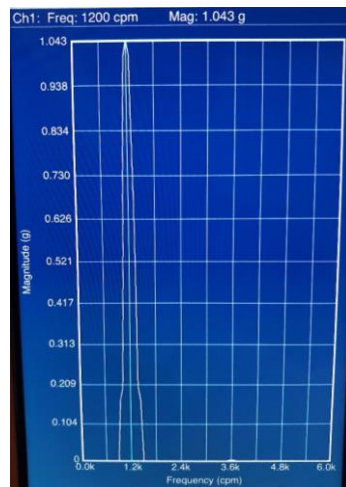

Test Point 2: Measured Vibration = 1.043 g pk at 1200 CPM



Test Point 3: Known Vibration = 1.00 g pk at 1800 CPM

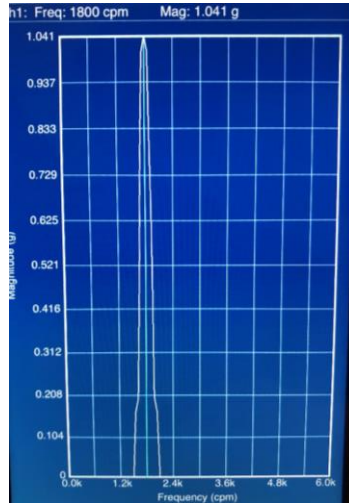

Test Point 3: Measured Vibration = 1.041 g pk at 1800 CPM



Test Point 4: Known Vibration = 1.00 g pk at 3000 CPM

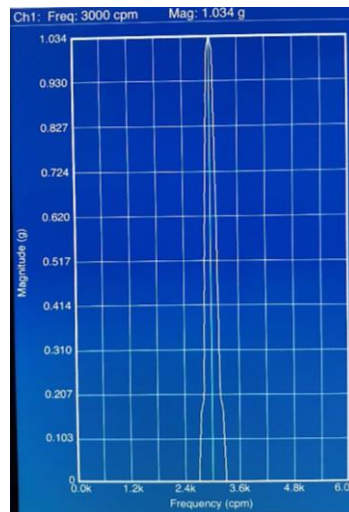

Test Point 4: Measured Vibration = 1.034 g pk at 3000 CPM



Test Point 5: Known Vibration = 1.00 g pk at 3600 CPM

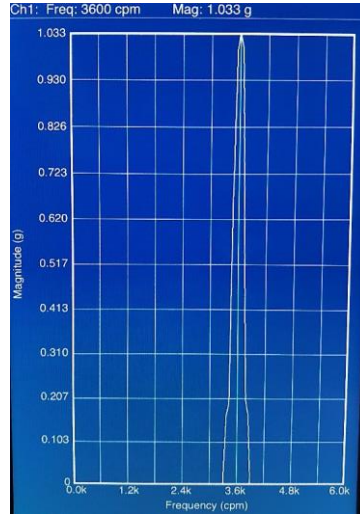

Test Point 5: Measured Vibration = 1.033 g pk at 3600 CPM



Test Point 6: Known Vibration = 1.00 g pk at 5700 CPM

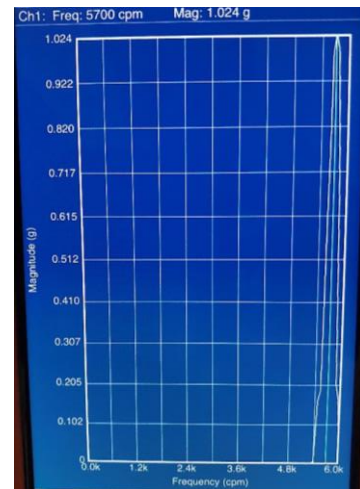

Test Point 6: Measured Vibration = 1.024 g pk at 5700 CPM

Frequency data can also be measured and recorded in Hz. Users must toggle from CPM to Hz on the 699B07 and also in the Signal Scope Pro FFT Analyzer settings.



Example known test point in Hz rather than CPM. Not used on sample certificate on next page.

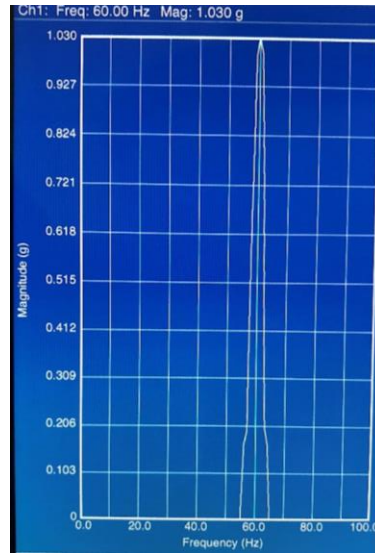

Example measured test point in Hz rather than CPM. Not used on sample certificate on next page.

3.5 Entering Frequency Response Test Data into the PVC Report Generation Workbook

Within the supplied Microsoft® Excel PVC Report Generation Workbook the raw data for the frequency response test is entered as shown below.

~ Vibration Analyzer Certification ~

Analyzer/Meter Information *		Analyzer Settings *		Print Linearity Test Certification
Manufacturer:	Faber Acoustical	Analyzer mode:	Spectra	Print Frequency Test Certification
Model Number:	SigScopePro	Frequency Max:	6000	
Serial Number:	n/a	Frequency Min:	0	Load Test Route
Cal. Tech:	Mike Scott	Frequency Unit:	CPM	
Cal. date:	2/7/2019	Lines of Resolution:		Reset Form
Cal. due:	2/7/2020	Averaging Points:	4	
		Window Type:	Flattop	
		Analyzer Sensor Input Sensitivity:		
		Unit:		

Test Equipment *									
Description	Model Number	Serial Number	Cal date	Cal. Sensitivity @ 100Hz	Unit	Meas. Sensitivity @ 100Hz	Unit	% Tolerance	% Deviation
PVC	699B07	10287	12/20/2018	10.22	mV/g	10.23	mV/g	3.00%	0.10%
Sensor					mV/g		mV/g	5.00%	
DMM	Fluke	12345	1/18/2019						

No.	Known Value		Measured Value		% Deviation	
	Amplitude	Frequency	Amplitude	Frequency	Amplitude	Frequency
1	0.800	600	0.838	600	4.75	0.00
2	1.000	1200	1.043	1200	4.30	0.00
3	1.000	1800	1.041	1800	4.10	0.00
4	1.000	3000	1.034	3000	3.40	0.00
5	1.000	3600	1.033	3600	3.30	0.00
6	1.000	5700	1.024	5700	2.40	0.00
7						
8						
9						
10						
11						
12						
13						
14						
15						

Test *	
Test Frequency:	
Freq Unit:	CPM
Test Amplitude:	1.000
Amp. Unit:	g pk

Due to shaker limitation, it may not be possible to maintain the same amplitude at all speed or the same frequency at all amplitude. If this occurs, calibration is still valid, but it is best practice to document any points where excitation could not meet requirement in the notes field of the certificate.

It is important to note the following:

- The Analyzer/Meter information including model and serial number
- Any applicable analyzer settings. For example, the Frequency Max, Lines of Resolution, Averaging and Window Type can all have an effect on accuracy.
- For this frequency response test we used a constant amplitude of 1.00 g pk where possible. At 600 CPM the shaker is not capable of generating 1.00 g pk thus we chose 0.80 g pk. The most common amplitude needs to be noted in the Test block on the right side of the form next to the raw data.
- The known values are noted from the screen of the Portable Vibration Calibrator.
- The measured values come from our FFT analyzer in the Signal Scope Pro application.
 - Note, in our experience frequency measurements seldom produce significant error. In our example the application measured the correct frequency each time and there was 0.00% deviation. However we can see that again, as in the linearity example, readings were consistently high.

4. PRODUCING THE FINAL CALIBRATION CERTIFICATES

4.1 Linearity Test

At top right, click “Print Linearity Test Certification”. Our sample report is shown below.

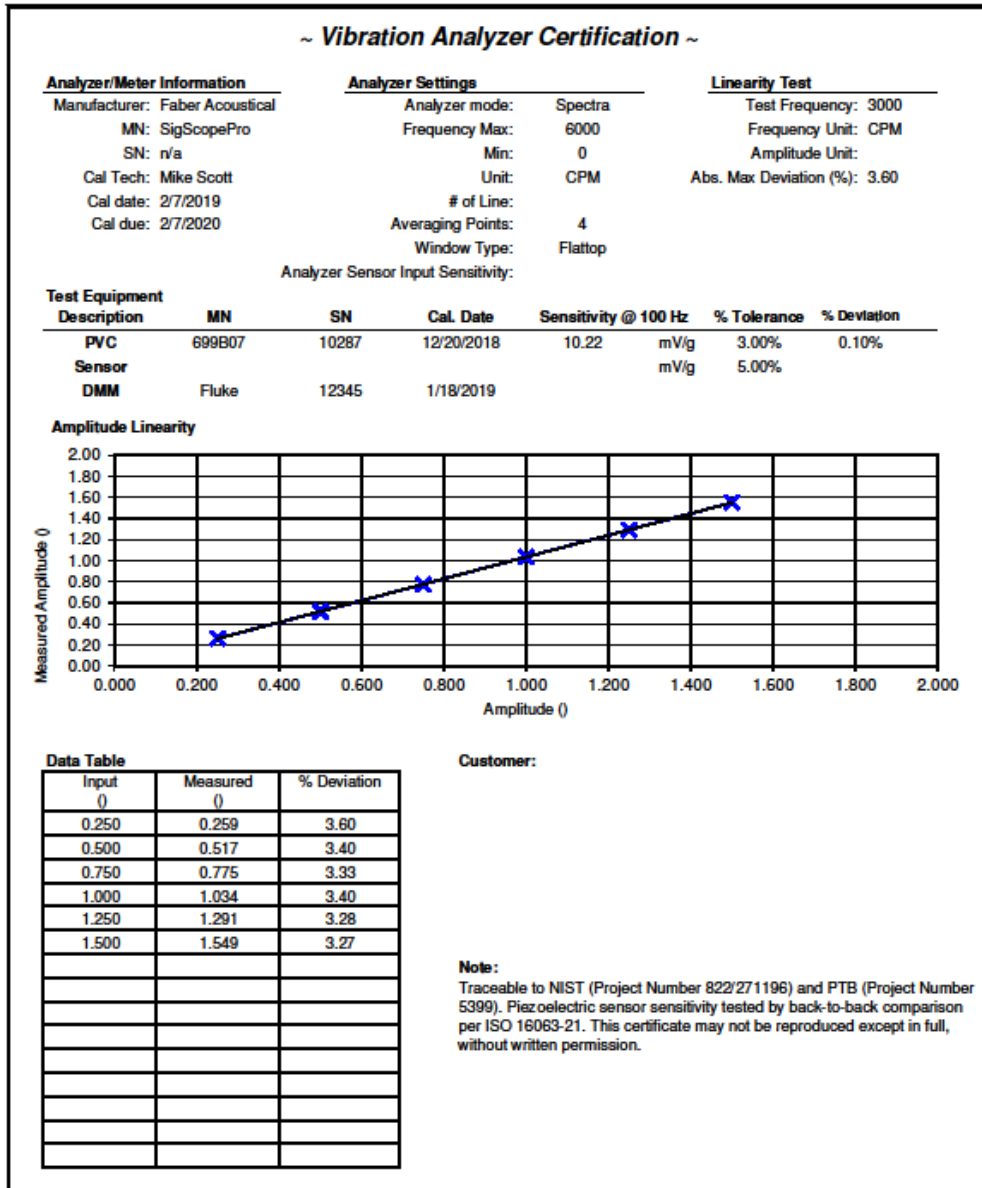

PCB Piezotronics, Inc.
3425 Walden Ave.
Depew, NY, 14043-2495, USA

Phone: 716.684.0002
Fax: 716.684.0987
www.pcb.com
info@pcb.com



PORTABLE VIBRATION CALIBRATOR

PRODUCT MANUAL | MODEL 699B07

PORTABLE VIBRATION CALIBRATOR

MODEL 699B07

PRODUCT SUPPORT

For answers to questions about this product, consult this manual or the accessory manual. For additional product support, contact PCB Piezotronics at 800.828.8840. If it is more convenient, fax your questions or comments to PCB Piezotronics at 716.684.0987 or email our technical staff at info@pcb.com.

WARRANTY

PCB Piezotronics, Inc. Series 699B Portable Vibration Calibrator & Shaker Table products are warranted against defective materials and workmanship for TWO YEARS from the date of shipment, unless otherwise specified. Damage to equipment caused by incorrect power, misapplication, or procedures inconsistent with this manual are not covered by warranty. If there are any questions concerning the intended application of the product, contact an Applications Engineer. Batteries and other expendable accessory hardware items are excluded.

COPYRIGHT

Copyright ©2019 PCB Piezotronics, Inc. This manual is copyrighted with all rights reserved. The manual may not be copied in whole or in part for any use without prior written consent of PCB Piezotronics, Inc.

DISCLAIMER

The following paragraph does not apply in any state or country where such statements are not agreeable with local law:

PCB Piezotronics, Inc. provides this publication “as is” without warranty of any kind, express or implied, including but not limited to, the implied warranties of merchantability or fitness for a particular purpose. This document is subject to change without notice, and should not be construed as a commitment or representation by PCB Piezotronics, Inc.

This publication may contain inaccuracies or typographical errors. PCB Piezotronics, Inc. will periodically update the material for inclusion in new editions. Changes and improvements to the product described in this manual may be made at any time.

TRADEMARKS

ICP® is a registered trademark of PCB Piezotronics, Inc.

Microsoft Excel® is a registered trademark of Microsoft Corporation in the United States and/or other countries.



3425 Walden Avenue
Depew, NY, 14043-2495, USA
Phone: 716.684.0002
FAX: 716.684.0987
www.pcb.com
info@pcb.com



SAFETY CONDITIONS

Prior to the installation and use of this product, review all safety markings and instructions. PCB Piezotronics, Inc. equipment has been designed and manufactured for use in an industrial environment to be operated by trained, qualified personnel.

The following warning markings and caution notes are used in the manual and on the equipment:



Denotes a Hazard That May Cause Injury, refer to this product manual for further instructions. PCB Piezotronics, Inc. products, like machinery and equipment with live and moving parts, can be a source of serious hazards unless properly used and protected. The level of noise may be unacceptable without protection under certain conditions.



Denotes a Possible Hot Surface, refer to this product manual for conditions that could result in a hot surface temperature



Denotes a Danger of Electrical Shock. The user is committed to ensure that: The handling, assembly, installation, connection, maintenance and repair operations are undertaken by qualified personnel whom by their background, training and experience as well as through their knowledge of statutory regulations, legislation, safety measures and operating conditions are able to carry out any necessary steps avoiding all possible risks to health and damage.

Caution! Denotes a hazard that can damage equipment or data

CAUTIONARY NOTES

- *Loads of up to 800 gram (28.3 oz) can be mounted directly to the 699B07 mounting platform. Larger loads may be applied to the platform, however, if prolonged testing of a heavy load is planned, we recommend using an external transducer suspension system. Under these conditions the vibration waveform should be viewed on the oscilloscope to aid in positioning the test transducer and platform to reduce distortion that can occur with very heavy weights.*
- *The 699B07 should always be operated on a stable, flat surface.*
- *The 699B07 is designed for field test applications but care must be taken to maintain the integrity of the mounting platform assembly.*
- *Hearing protection recommended when operating the 699B07 for an extended amount of time.*

TABLE OF CONTENTS

1. INTRODUCTION.....	5
1.1 SUPPLIED ACCESSORIES.....	6
1.2 OPTIONAL FIXTURING & ACCESSORIES.....	7
1.3 REPLACEMENT ACCESSORIES.....	7
1.4 RECALIBRATION SERVICES.....	7
2. 699B07 OPERATION GUIDE	8
2.1 REPORT GENERATION WORKBOOK.....	11
2.2 ADDITIONAL FEATURES	12
2.3 CALIBRATION ROUTE	15
2.4 CHARGE MODE OPERATION.....	19
2.5 MODULATED CURRENT	20
2.6 DEFINITION OF FREQUENCY UNITS	21
2.7 DEFINITION OF AMPLITUDE UNITS	21
2.8 MOUNTING BASICS	22
2.9 INPUT / OUTPUT.....	22
3. THEORY OF OPERATION	24
3.1 INSTRUMENTATION.....	24
3.2 BATTERY & CHARGER	26
4. SPECIFICATIONS & PERFORMANCE	27
5. RECOMMENDED PRACTICES	30
5.1 TESTING THE INTERNAL REFERENCE ACCELEROMETER FOR DRIFT	30
5.2 OPERATIONAL VERIFICATION & RECALIBRATION.....	31
5.3 STANDARD CHECKS FOR TRANSDUCERS	31
5.4 TYPICAL ACCELEROMETER & VELOCITY SENSOR CHECKOUT.....	31
5.5 NON-CONTACT DISPLACEMENT SENSOR CALIBRATION	33
5.6 NON-CONTACT DISPLACEMENT SENSOR TEST SETUP.....	34
5.7 PROXIMITY PROBE DYNAMIC LINEARITY CALIBRATION & CONFIRMATION OF VIBRATION ALARMS	36
5.8 TROUBLESHOOTING THE PROXIMITY PROBE SYSTEM	37
5.9 CREATING A PROXIMITY PROBE CURVE IN MILS.....	38
5.10 TESTING 4-20 MA VIBRATION TRANSMITTERS	39
5.11 CREATING A TEST REPORT FOR 4-20 MA VIBRATION TRANSMITTERS.....	39
5.12 MAINTENANCE	40

1. INTRODUCTION

Thank you for choosing Model 699B07.

The Model 699B07 Portable Vibration Calibrator provides a field tested method for on-the-spot dynamic verification of accelerometers, velocity pickups and non-contact displacement transducers. Optional mounting fixtures and hardware needed to connect transducers to the 699B07 mounting platform are available upon request.

A closed-loop control algorithm provides enhanced stability and accuracy of frequency and amplitude levels.

The 699B07 incorporates a built-in sine wave oscillator, power amplifier, electrodynamic shaker, NIST traceable reference accelerometer, digital display, and internal memory. The 699B07 is completely self-contained and operates on battery or AC power.

The built-in reference accelerometer is attached permanently to the shaker armature, maximizing the accuracy between the reference accelerometer and the test transducer. The 699B07 is designed to provide long-term reliable performance over the frequency range of 5 Hz to 10 kHz. The 699B07 can be used for a variety of applications that include:

- Verification and calibration of vibration transducers and related vibration test systems
- Verification of connector and cabling integrity
- Confirm machine vibration alarm trip points are set properly and ensure end-to-end functionality of vibration monitoring systems.



1.1 Supplied Accessories

Accessories pictured below are included with each 699B07 Portable Vibration Calibrator.



Mounting Wrench



Power Supply and Plug Adaptors (600A25)



Accessory Pouch

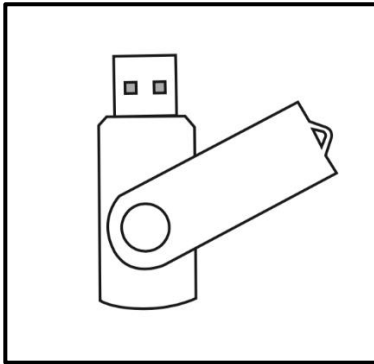

USB Loaded with Report Generation Workbook

PVC
Portable Vibration Calibrator
Report Generation Spreadsheet
Version: 3.0.7
10/1/2016

Frequency Hertz	Amplitude g's pk	Sensitivity mV/g	Deviation %
7	0.35	0.91	-0.4
7.5	0.42	0.91	-0.4
8	0.54	0.87	-0.8
9	0.62	0.91	-0.4
10	1.00	0.90	-0.5
30	1.00	0.94	-0.1
50	1.00	0.96	0.1
100	1.00	0.95	0.0
300	1.00	0.98	0.2
400	0.99	0.99	0.3
499	0.99	0.99	0.4
780	0.99	10.01	0.5
1500	0.99	10.02	0.6
2050	0.99	10.00	0.5
2800	0.99	10.02	0.7
3000	0.99	10.02	0.7

-Certificate of Calibration-

Manufacturer: IMI Sensors Calibration Date: 21 Jan 19
 Model Number: 699B07 Calibration Dev: 0.0000
 Serial Number: 000000 Temperature: 22.5 °C
 Description: Portable Vibration Calibrator Humidity: 55.3 %
 Test Procedure: PVC 3.0.7

Calibration Tech: BTB g_{pk} ±0.02
 Customer: _____

As Supplied: 10.000000 Internal Reference: _____
 As Rec'd: In Tolerance Sensitivity @ 100 Hz: 0.93 mV/g
 (Measured at Minimum Reference Dev. 0.0%)

Measured	Reference	Measured	Reference	Measured	Reference	Measured	Reference
Amplitude	Sensitivity	Amplitude	Sensitivity	Amplitude	Sensitivity	Amplitude	Sensitivity
(g _{pk})	(mV/g)	(g _{pk})	(mV/g)	(g _{pk})	(mV/g)	(g _{pk})	(mV/g)
7	0.35	0.35	0.35	0.60	0.95	0.15	0.15
7.5	0.42	0.42	0.42	0.68	0.95	0.17	0.17
8	0.54	0.54	0.54	0.82	0.95	0.20	0.20
9	0.62	0.62	0.62	0.92	0.95	0.22	0.22
10	1.00	1.00	1.00	1.00	0.95	0.25	0.25
30	1.00	1.00	1.00	1.00	0.95	0.25	0.25
50	1.00	1.00	1.00	1.00	0.95	0.25	0.25
100	1.00	1.00	1.00	1.00	0.95	0.25	0.25
300	1.00	1.00	1.00	1.00	0.95	0.25	0.25
400	1.00	1.00	1.00	1.00	0.95	0.25	0.25
499	1.00	1.00	1.00	1.00	0.95	0.25	0.25
780	1.00	1.00	1.00	1.00	0.95	0.25	0.25
1500	1.00	1.00	1.00	1.00	0.95	0.25	0.25
2050	1.00	1.00	1.00	1.00	0.95	0.25	0.25
2800	1.00	1.00	1.00	1.00	0.95	0.25	0.25
3000	1.00	1.00	1.00	1.00	0.95	0.25	0.25

Notes:
 1. This document certifies that the above items published specifications.
 2. The equipment information shown has been calibrated using standards traceable to NIST (NIST.org) Number 17014 and 17016 monthly via the IMI Model Shop.
 3. The main document in this certificate refers only to the items listed or calibrated.
 4. This certificate may be reprinted, except for the values in the main content of the model shop.
 5. Measurement uncertainty (1% confidence level) with coverage factor 2 for frequency range is as being condition on amplitude 1.0 g_{pk}, 4.0 Hz, 100 Hz, 0.5 Hz, 100 Hz, 1.0 Hz, 100 Hz, 1.0 Hz, 100 Hz, 1.0 Hz, 1.0 Hz.
 6. Calibration performed at the Model Shop, 10411 4th Street, #6, Cincinnati, OH 45241, USA.
 7. Frequencies below 7 Hz are not A2LA accredited.

IMI SENSORS
 A PCB PIEZOTRONICS DIV.
 Calibration Laboratory
 Certificate Number 2400101
 PVC 3.0.7 rev. 6/2015 Calibration ID: 121179 12132

A Certificate of Calibration is also included with every new unit. PCB Piezotronics recommends annual recalibration of the 699B07 unit. The factory service code for the recalibration is ICS-41.

Mounting Accessories

- ¼-28 to ¼-28 Mounting Stud (081B20)
- 10-32 to ¼-28 Mounting Stud (081A08)
- M8 x 1.25 M to ¼-28 M Mounting Stud (M081A63)
- M8 x 1.25 F Thru Hole Mounting Pad (600A54)
- M8 x 1 F Thru Hole Mounting Pad (600A55)
- Mounting Plate, 3- & 4-Hole High-Temp Vibration Sensors (600A56)
- Mounting Plate, 3- & 4-Hole High-Temp Vibration Sensors (600A57)

1.2 Optional Fixturing & Accessories

For operation in certain applications, such as calibration of non-contact displacement sensors, PCB offers optional mounting fixturing. Reference the table below when ordering these optional adaptors and accessories.

ACCESSORY	DESCRIPTION
600A24	Mounting accessory kit for 699 Series Portable Vibration Calibrators, to adapt to ¼-28 threaded mounting platforms. Includes studs/inserts (¼-28, 10-32, 6-32 and 5-40) and bases (for adhesive, magnetic, and custom thread patterns).
600A23	Proximity probe adaptor kit, supports probes with common case threads ranging from M6 to 3/8". Includes Mitutoyo micrometer (metric) and 699-PPA02 nickel-plated 4140 steel target.
600A22	Proximity probe adaptor kit, supports probes with common case threads ranging from M6 to 3/8". Includes Mitutoyo micrometer and 699-PPA02 nickel-plated 4140 steel target.
080M406	¼" NPT F mounting adaptor to ¼-28 M
600A56	Mounting adapter plate for 3 and 4-hole bolt pattern vibration sensors commonly used in high-temp applications. Used for mounting sensors made by Bently Nevada, CEC, Metrix, PCB, Dytran and Endevco to portable vibration calibrators with 1/4-28 F thread
600A57	Mounting adapter plate for 3 and 4-hole bolt pattern vibration sensors commonly used in high-temp applications. Used for mounting sensors made by Vibro-Meter and PCB to portable vibration calibrators with 1/4-28 F thread.
600A54	M8 x 1.25 F mounting pad
M081A63	M8 x 1.25 to ¼-28 mounting stud adaptor
600A55	M8 x 1.0 F mounting pad
081M165	M8 x 1 to ¼-28 mounting stud adaptor

1.3 Replacement Accessories

ACCESSORY	DESCRIPTION
600A25	18 Volt, 1 amp power supply/charger for 699B07 Portable Vibration Calibrator, universal 100-240 V, 50/60 Hz.
600A26	Replacement battery for 699 Series Portable Vibration Calibrators.

1.4 Recalibration Services

It is recommended the 699B07 be returned to PCB Piezotronics for calibration once a year.

ACCESSORY	DESCRIPTION
ICS-41	Calibration of 699 Series Portable Vibration Calibrator

2. 699B07 OPERATION GUIDE

For the following section, “point” is defined as the numerical value of the amplitude at a given frequency. “Record” is defined as the collection of all numerical calibration points at different frequencies and amplitudes saved together.

For the basic operation of the 699B07, a vibration sensor and appropriate cable are needed. Typically the 699B07 is used as a vibration excitation source and as a readout device with the vibration sensor connected to the 699B07’s Test Sensor BNC Input. Alternatively, the 699B07 unit can be used to test different types of vibration equipment (i.e. a vibration meter or vibration monitoring system), in which case the sensor will be directly connected to the vibration measurement equipment and the 699B07 is used just as a controlled excitation source.

Test Setup

Step 1 Mount your sensor to the 699B07 mounting platform



The 699B07 sensor mounting platform is threaded for a ¼-28 stud. Select an appropriate adaptor for mounting the sensor.

While tightening the sensor, secure the 699B07 mounting platform with the supplied wrench to prevent damage from torque.

Step 2 Connect sensor under test (SUT) to “Test Sensor In.” Make sure that connections are secure.

Step 3 Power the unit ON by pressing and holding the **FREQUENCY** dial for 3 seconds.

NOTE: It is good practice to perform calibrations on battery power. Disconnecting from line power ensures a power surge will not cause the calibrator to power down during test. If excess current is detected during use, the portable calibrator shuts down to prevent damage.

Selecting Input Mode

Step 1 The 699B07 can accept ICP® as well as AC voltage and AC current output sensors. Press and hold the **AMPLITUDE** dial to select between ICP®, Voltage Mode, Charge or Modulated Current mode.

Note: ICP® (or IEPE) mode sensors are the most popular type of accelerometer transducers and require a 2 mA to 20 mA constant current supply to operate. The 699B07 unit supplies the necessary constant current to power this class of sensors. Voltage output sensors are typically moving coil velocity sensors but can also be the voltage output of a signal conditioner associated with any type of vibration transducer such as the output from the probe driver in a proximity probe system. Charge Mode accelerometers must be connected to a charge converter. Refer to the Sensor Signal Measurement Electronics (SUT Input Characteristics and Considerations) or Charge Mode Operation sections for details.

Setting the Frequency & Amplitude Units

Step 2 Select the correct Frequency Units for your test by pressing the **FREQUENCY** dial to enter into the **CALIBRATION OPTIONS** menu:

- Use the **FREQUENCY** dial to highlight **TEST SETTINGS** then press.
- Within the Test Settings Menu rotate the **FREQUENCY** dial to highlight **FREQUENCY UNIT** then press to toggle between Hertz and CPM.

Step 3 Select the correct Amplitude Units for your test by pressing and releasing the **AMPLITUDE** dial. The following options are available:

ACCELERATION	VELOCITY	DISPLACEMENT
g's pk	In/s pk	Mils p-p
g's RMS	In/s RMS	µm p-p
m/s ² pk	mm/s pk	
m/s ² RMS	mm/s RMS	

Step 4 Select the desired vibration amplitude and frequency for testing by turning the **AMPLITUDE** and **FREQUENCY** dials clockwise to increase or counter clockwise to decrease the setting.

Step 5 Once the frequency and amplitude are set to desired values, with the file menu set to "Save Point," press the **FILE** dial to store the calibration data point.

Step 6 Repeat steps 7 through 9 to set the frequency and amplitude to increment to the next calibration data point and save.

Completing and Storing Record to Memory

Step 7 Once all data points have been saved in a record and record is complete, rotate **FILE** dial and press it to select "End Record."

- The screen will prompt with:

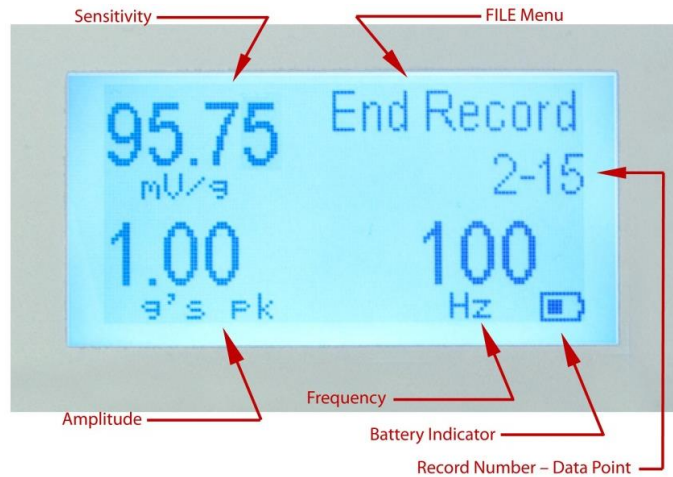

Step 8 Rotate the **FILE** dial to "Edit" to enter the model number, serial number and axis. The **FILE** menu for this screen also includes the tools "Next" and "Back."

- Push the **FILE** dial to choose "Next," which goes to the next save screen.

Step 9 To "Save" the record without inputting an annotation, press the **FILE** dial two more times.

Step 10 Rotate the **FILE** dial to “Edit” and press to store any annotations or additional notes (such as technician initials, etc):

- Turn the **FILE** dial to the left and right to select each individual letter or number you wish to input as part of an annotation. Push the **FILE** dial to save each character.
- Rotate the **FILE** dial and select “Save.” This will save all data points in the listed record number. The record number shown on the screen increments automatically.

Transfer Records to USB Flash Drive

Step 11 Rotate **FILE** dial and press to select “Tools.”

Step 12 Rotate **FILE** dial and press to select “USB Menu.”

- A USB flash drive must be connected to the unit. The USB must be formatted to FAT32. You can use the 699B07 or a PC to format the flash drive.

Step 13 To copy all data points and records to a USB Flash Drive, rotate **FILE** dial and press to select “Copy All Records.”

- This will leave current records on unit memory and also create a copy on the USB.

Step 14 To move all data points and records to USB, rotate **FILE** dial and press to select “Move All Records.”

- This will remove current records on unit memory and move onto the USB.

Note: The USB hardware may not always recognize a USB flash drive if it is plugged into the USB port while the 699B07 is in sleep mode. PCB Piezotronics recommends connecting the USB drive while the 699B07 is on and operational.

Powering Off

Step 15 *Suggested Best Practice:* Before powering the unit OFF, reduce the vibration amplitude. The 699B07 retains the settings used prior to shutdown when it is powered back ON. Reducing the amplitude prior to shutdown ensures the sensor under test will not be jarred when the 699B07 is powered ON.

Step 16 Power the unit OFF by pressing and holding the **FREQUENCY** dial for approximately 3 seconds.

- To preserve battery charge, the 699B07 will automatically power off after 20 minutes of inactivity when not plugged in to the charger.

After Testing

Step 17 *Suggested Best Practice:* Plug the 699B07 into an AC power source when not in use. This will ensure the batteries are fully charged for your next test and also help to maximize the lifespan of the batteries.

Step 18 Periodic calibration checks are recommended:

- A dedicated “verification sensor” can be used to check the system readings and results. By using a dedicated sensor, you can ensure that the system is providing the same result during each test. Contact PCB Piezotronics for more information on reference accelerometer options.
- The 699B07 should be returned to PCB Piezotronics for regular recalibration (recommended annually - Service Code ICS-41) or for any maintenance or repair. The most current factory calibration date or the calibration due date is displayed on the LCD screen during the 699B07 boot up sequence. The default due

date is set for 12 months after the last factory calibration, but the calibration interval can be user defined to be anywhere from 1 to 72 months, or set up to never expire.

2.1 Report Generation Workbook

Calibration data can be saved into the 699B07's internal memory and easily exported to a personal computer using a USB Flash Drive.

The 699B07 Portable Vibration Calibrator includes a pre-formatted USB Flash Drive with a Microsoft Excel® Report Generation Workbook for the creation of customizable calibration certificates. The Excel file provides an intuitive interface which allows a user to create and print a calibration certificate with just a few mouse clicks. In order to use the file, make sure macros are enabled, otherwise Excel won't be able to load data and create the certificates.

The Excel workbook consists of the following worksheets or tabs:

- **FRData** – Use this tab to create a frequency response certificates in just 2 steps:

Step 1 Clicking on Import Data from File button prompts the user to select and import a .pvc calibration data file previously created by the 699B07

Step 2 Once data is loaded into the table, click View Certificate to see and print a calibration certificate containing the frequency response data (the reference frequency for the calibration certificate is 100Hz and can be changed by the user as needed)

Note: If testing a charge-mode accelerometer and calibration certificate in pC units is desired, click the box at top left of the FRData tab and enter the sensitivity of the charge amplifier in the "mV/pC" box located at cell D8. See the section "Calibrating Charge-Mode Accelerometers" for more information.

- **LINData** – Use this tab to create linearity response certificates. The worksheet applies linear regression to interpolate the data. The **Max Linearity** is calculated for the worst deviation of a particular point from the best-fit straight line (BFSL) of all tested points. The table also displays the specific results at each test level. The LINData worksheet has 2 tables. The left table should be used for creating dynamic linearity data calibration certificates in just 2 steps:

Step 1 Click on Import Data from File to select and import a .pvc calibration data file previously created by the 699B07

Step 2 Once data is loaded into the table, click View Certificate to see and print a calibration certificate containing the linearity response data. The worksheet expects the data points to be taken at the same frequency (speed). A checkbox option labeled Set Y-intercept to zero is available to force the interpolation to go through the origin point.

The right table in the LINData worksheet is used to create a DC proximity probe curve or linearity certificate for 4-20 mA vibration transmitter. Creating a DC proximity probe curve requires the 600A22 or 600A23 proximity probe adaptor kits and a DC voltmeter (not included). Creating a linearity certificate for a 4-20 mA vibration transmitter requires DMM set to DC current input.

Step 1 Select the appropriate vibration scale (Acceleration, Velocity or Displacement) by clicking in cell H12 and selecting from drop down menu.

Step 2 Select the appropriate units (g's pk, g's RMS, m/sec² pk, m/sec² RMS, in/sec pk, in/sec RMS, mm/sec pk, mm/sec RMS, mils p-p or μ m p-p) in cell H13. Make sure cell H12 is set to the right scale first.

Step 3 Enter known amplitude and output for the first test point next to "Starting Point" and repeat for each additional test point moving down the table. Once data is entered into the table, click View Certificate to see and print a calibration certificate containing the linearity response data.

- **Route Creator** – This tab can be used to create semi-automated tests with instant pass/fail notification for almost any vibration sensor. See “Calibration Route” for more information.
 - **Vib Analyzer Data** – This tab is used to manually enter information and data pertaining to an in-house calibration of a vibration analyzer and meter. Vibration Analyzer Field Calibration Manual (MAN-0320) provides complete step-by-step instruction on creating vibration analyzer calibration reports. It is supplied with the 699B07 and digital copies are available by contacting PCB Piezotronics.
 - **FRCert** - Displays the frequency response calibration certificate using the current data and information from FRData. This tab is displayed after the user clicks “view certificate on the FRData tab.
- Step 1** LINCert - Displays the linearity response calibration certificate using dynamic linearity data from LINData. This tab is displayed after the user clicks “view certificate on the LINData tab when using the dynamic linearity table on the left.
- Step 2** SLINCert - Displays the linearity response calibration certificate using static linearity data from LINData. This tab is displayed after the user clicks “view certificate on the LINData tab when using the static linearity table on the right.

2.2 Additional Features

Delete

The “Delete” feature can be found under the FILE dial > “Delete.” When “Delete” is selected, the shaker will stop moving and four options will appear:

- Step 1** “Delete Point” will delete a current point.
- Step 2** “Delete Record” will delete the entire current record.
- Step 3** Delete All” will delete all data points and all records that are stored on the internal unit memory.
- Step 4** “Back” will return to the main screen.

USB Options

The “USB Options” feature can be found under the **FILE** dial > “Tools” > “USB Menu” > “USB Options.” When “USB Options” is selected, the following information will appear on the screen:

- “Status” – USB flash drive connected or not connected.
- “Partition” – Format of USB flash drive connected to the unit.
- “Available” – Memory space available on USB flash drive.
- “Required” – Space required to save all records on USB flash drive.

And the following actions are available:

- “Eject Drive” will safely eject the USB flash drive from the unit.
- “Format USB” for formatting the USB flash drive. (FAT32 partition)
- “Back” to go back to the USB Menu.

Date and Time

The “Date and Time” feature can be found under the **FILE** dial > “Tools” > “Options” > “Date and Time.”

Step 1 Press the **FILE** dial to select “Adjust.”

Step 2 Turn the **AMPLITUDE** dial to select the current month, day and year and push the **FREQUENCY** dial to confirm or the **AMPLITUDE** dial to change.

Step 3 Press the **AMPLITUDE** dial to select “yes” this is correct.

Step 4 Turn the **AMPLITUDE** dial to select the current hours and minutes then push the **FREQUENCY** dial to confirm the time is correct. Press the **AMPLITUDE** dial to select “yes” this is correct

Calibration Interval

The “Calibration Interval” can be adjusted under the **FILE** dial > “Tools” > “Options” > “Calibration Interval.”

Step 1 Select “Adjust” and press **FILE** dial.

Step 2 Turn **AMPLITUDE** dial to select number of months for Calibration Interval.

- *Suggested Best Practice: 12 months.* The calibration interval can be defined to be anywhere from 1 to 72 months, or set up to never expire.

Step 3 Press **FREQUENCY** dial to confirm selected Calibration Interval.

Traceability

The “Traceability” feature can be found under **FILE** dial > “Tools.”

Step 1 Press **FILE** dial to select “Traceability.” A screen with the following information will appear

- Model
- Serial Number
- Firmware Revision Number
- Calibration Date
- Reference Sensor Sensitivity
- PRD-P
- NIST Traceability Number
- PTB Traceability Number

Step 2 Press **FILE** dial to go back to main screen and shaker will go back to shaking.

Test Settings

The “Test Settings” menu can be found by pressing **FREQUENCY** dial > “Test Settings.” A screen with the following will appear, use the **FREQUENCY** dial to highlight and toggle all settings:

- Back – returns user to “Calibration Options” menu
- Cal Route: Active or Off

- Active indicates that the 699B07 is currently running a programmed and uploaded CALROUTE. Turning the FREQUENCY dial will advance the unit from point to point. Turning the AMPLITUDE dial produces no response in this mode.
- Off indicates that the 699B07 is in manual operation mode. The frequency and amplitude will adjust if the user turns their respective dials.
- Source: Internal or External
 - If external is selected the shaker can be controlled with an external source. See “Input/Output” for more information.
- Frequency Unit: Hertz or CPM (cycles per minute)
- Sensor Type: ICP®, Voltage, Modulated Current or Charge
 - Use ICP® for most accelerometers, Voltage for proximity probes and moving coil sensors, Modulated Current for high-temp turbine vibration sensors with AC current output, Charge for charge mode sensors with pC/EU output. See “Selecting the Input Mode” for more information.
- Sensor Readout: mV/EU or mV
 - Changes the display to show the sensor under test’s sensitivity (output voltage divided by input vibration, mV/EU) or the sensor under test’s raw AC output voltage.

Amplitude Units

Amplitude units that are seldom or never used can be turned off by using the “Amplitude Units” feature, found by pressing **FREQUENCY** dial > “Amplitude Units.”

The “Amplitude Unit Screen” shows all 10 available amplitude scales on model 699B07 Portable Vibration Calibrator. Use the **FREQUENCY** dial to highlight each scale and press the dial to toggle the scale on or off. A filled circle next to the scale indicates it is active. An empty circle next to the scale indicates it is inactive. Inactive scales do not appear when cycling through scales using the **AMPLITUDE** dial during normal operation.

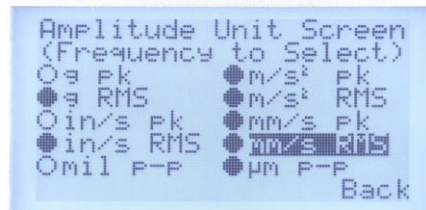

AMPLITUDE

FREQUENCY

To go back to the “Calibration Options” menu use the FREQUENCY dial to highlight “Back” then press.

2.3 Calibration Route

The Calibration Route firmware allows users to create and run semi-automated frequency response and amplitude linearity tests for vibration sensors on model 699B07 with instant pass/fail notification. Tests or “routes” are created in the Report Generation Workbook then uploaded to the 699B07 via supplied USB drive. Once uploaded the test is activated. But the test can also be de-activated at any time, putting the 699B07 back into manual operation mode. When a Calibration Route is active the 699B07 can only adjust to the pre-defined amplitude and frequency points that have been programmed.

Creating A New Test (Route)

Version 2010 or later of Microsoft Excel® is required for the CalRoute features in Report Generation Workbook to operate correctly. Drop-down arrows for frequency and amplitude units may not appear if using older versions of this software.

- Step 1** Open the Report Generation Workbook (version 3.1.0 or later required) using Microsoft Excel®
- Step 2** At bottom, select the **Route Creator** tab
- Step 3** **Route Name:** Enter the name of the test in cell B7 next to “Route Name”. When the test file is created and saved the file name will be this value followed by “_Route.pvc”.
- Step 4** **Frequency Unit:** Use the drop down arrow to choose the frequency unit (Hertz or CPM) in cell B8. One cannot toggle between Hertz and CPM during the test.
- Step 5** **Amplitude Unit:** Use the drop down arrow to choose the amplitude unit (g pk, g RMS, m/sec² pk, m/sec² RMS, in/sec pk, in/sec RMS, mm/sec pk, mm/sec RMS, mils p-p or μm p-p) in cell D7.
- Step 6** **Amplitude:** If desired, enter the amplitude for all test points in cell B9 next to “Amplitude”. This is useful for a frequency response test where all test points will have the same amplitude value. If creating a linearity test leave this cell blank since the amplitude values will change for each test point.
- Step 7** **Sensor Type:** Use the drop down arrow in cell F7 to select the sensor type (ICP®, Voltage, Charge or Modulated Current).
- Step 8** **Sensor MN:** if desired, enter the sensor model number in cell F8. This is optional. The sensor model number that is entered will print on the calibration certificate. It can be changed at any time. If the model number is not consistent leave this cell blank.
- Step 9** **Lower Bound:** in cell D8 enter the minimum sensitivity value for the sensor under test at each test point that will pass calibration test. For example, the minimum acceptable sensitivity for 100 mV/g accelerometer with +/- 5% sensitivity tolerance is 95 mV/g, thus lower bound would be: 95.00.
- Step 10** **Upper Bound:** in cell D9 enter the maximum sensitivity value for the sensor under test at each test point that will pass calibration test. For example, the maximum acceptable sensitivity for 100 mV/g accelerometer with +/- 5% sensitivity tolerance is 105 mV/g, thus upper bound would be: 105.00.
- Step 11** Press **Table Auto-Fill**. The grey cells in the table will automatically populate with the values chosen in steps 3-10. All cells will populate. The table is capable of creating a 30-point test. But any number of test points can be programmed. Before creating the route file user must delete values in cells for test points that should not be created (see example).
- Step 12** Enter the desired **Frequency** values for each test point in column A beginning with cell A13. The test will be conducted in the exact order as programmed. The first test point will be as programmed in row 13; the next will use row 14 values and so on.

Step 12a The 699B07 can only simulate vibration in CPM values that are multiples of 60. I.e. 1800 CPM, 3600 CPM, 4200 CPM, etc. If a value is entered that is not a multiple of 60, the 699B07 will adjust down to the nearest CPM value that is a multiple of 60.

Step 12b Example: 1900 CPM is entered as a test point. The 699B07 will adjust to 1860 CPM and 1860 CPM will be displayed.

Step 13 Enter the desired **Amplitude** values for each test point in column B beginning with cell B13. Skip this step if all amplitude values have been automatically populated using the Table Auto-Fill button.

Step 14 Modify any individual test point as desired. For example, most accelerometers have a wider sensitivity tolerance at extreme low and high frequencies. User may wish to expand the upper and lower bounds for certain test points.

Step 15 There is no need to delete incomplete rows. Incomplete rows will not be programmed. However incomplete rows followed by complete rows will cause an error. I.e. if the user leaves the frequency call blank that row will not be programmed.

Step 16 Press **Create Route File**. A .pvc file will be created, save this file to the USB drive in the **Calibration_Route** folder.

Step 16a When prompted to save, open the USB Disk

Step 16b Open the CalRecords_PVC folder

Step 16c Open the Calibration_Route folder

Step 16d Press save

Example Accelerometer Test (Route)



PVC
 Portable Vibration Calibrator
 Calibration Route Generation Spreadsheet
 Version: 3.1.0

1) Table Auto-Fill

2) Create Route File

Route Name	CaseAccel	Amplitude Unit	g pk	Sensor Type	ICP
Frequency Unit	Hertz	Lower Bound	95.00	Sensor MN	622B01
Amplitude	1.00	Upper Bound	105.00		

Reset Form

Frequency	Amplitude	Amplitude Unit	Lower Bound	Upper Bound	Sensor Type
10	1.00	g pk	95.00	105.00	ICP
50	1.00	g pk	95.00	105.00	ICP
100	1.00	g pk	95.00	105.00	ICP
300	1.00	g pk	95.00	105.00	ICP
500	1.00	g pk	95.00	105.00	ICP
1000	1.00	g pk	95.00	105.00	ICP
2000	1.00	g pk	95.00	105.00	ICP
3000	1.00	g pk	95.00	105.00	ICP
4000	1.00	g pk	95.00	105.00	ICP
5000	1.00	g pk	95.00	105.00	ICP

An example of a 10-point accelerometer test, created in the Report Generation Workbook, is shown above. Some helpful notes...

- When run, this test will shake the accelerometer at 1g pk at all points. If the shaker cannot generate 1g pk it will output the maximum vibration possible given the sensor's weight and test speed. The shaker will not allow user to program points that can damage the shaker.

- The test will begin at 10 Hz and end at 5000 Hz, with test points at 50,100, 300, 500, 1000, 2000, 3000 and 4000 Hz as well.
- If the sensor under test's sensitivity is above 105 mV/g or below 95 mV/g the 699B07 will alert the user that test point failed.
- The file name will be CaseAccel_Route.pvc, when uploading to the 699B07 one would choose this file.
- ICP® power is active for all test points. If this test were applied to a self-powered sensor data would be invalid. One would select "Voltage" for a self-powered sensor such as a moving coil velocity transducer.

Example Proximity Probe Test (Route)

Route Name	ProxProbe	Amplitude Unit	mil p-p	Sensor Type	Voltage
Frequency Unit	CPM	Lower Bound	190.00	Sensor MN	330101
Amplitude		Upper Bound	210.00		

Frequency	Amplitude	Amplitude Unit	Lower Bound	Upper Bound	Sensor Type
3600	1.0	mil p-p	190.00	210.00	Voltage
3600	2.0	mil p-p	190.00	210.00	Voltage
3600	3.0	mil p-p	190.00	210.00	Voltage
3600	4.0	mil p-p	190.00	210.00	Voltage
3600	5.0	mil p-p	190.00	210.00	Voltage
3600	6.0	mil p-p	190.00	210.00	Voltage
3600	7.0	mil p-p	190.00	210.00	Voltage
3600	8.0	mil p-p	190.00	210.00	Voltage
3600	9.0	mil p-p	190.00	210.00	Voltage
3600	10.0	mil p-p	190.00	210.00	Voltage

An example of a 10-point proximity probe test, created in the Report Generation Workbook, is shown above. Some helpful notes...

- This test will simulate vibration at 3600 CPM for all test points.
- This is a linearity test. Vibration will start at 1.0 mils p-p and escalate to 10.0 mils p-p. The sensor will be evaluated every 1.0 mils.
- The test is designed for a 200 mV/mil proximity probe with 5% tolerance. Thus sensitivity of 190-210 mV/mil passes calibration. If outside those values the 699B07 will indicate the test point has failed.
- The sensor type is voltage. This means ICP® power is turned off. The proximity probe is being powered by its probe driver. To run this test the technician must connect the output of the probe drive to "Test Sensor In" on the 699B07.
- The name of the file will be ProxProbe_Route.pvc.
- The model number 330101 will print on each test report created using this route. It can be modified on the certificate if desired to add thread lengths, cable length, etc.

Loading & Activities a Calibration Test (Route)

With the calibration test saved as a .pvc file to the Calibration_Route folder on the USB and the USB inserted into the port on the 699B07 the following instructions detail how to upload to model 699B07 and activate:

- Step 1** Press the **FREQUENCY** dial to enter “Calibration Options” menu, rotate to highlight **TEST SETTINGS** and press again to enter “Test Settings” menu.
- Step 2** Use **FREQUENCY** dial to highlight and click selection next to “Cal Route:”. Selection will be “Off” or “Active” depending upon previous status. When clicked user will enter into “Route Option” menu.
- Step 3** Use **FREQUENCY** dial to highlight and click on **LOAD FILE FROM USB**
- Step 4** Up to six route files (tests) are shown. Use **FREQUENCY** dial to highlight and click on desired file.
- Step 5** Display will indicate “Route Load Successful Activate Now?” To activate press the **AMPLITUDE** dial.
- Step 5a** To load to memory but not activate the test press **FREQUENCY**.

The calibration test is now loaded and active. Rotating the **FREQUENCY** dial allows user to scroll through programmed test points without saving data.

Executing the Semi-Automated Calibration Test (Route)

The calibration test has been created and saved to the USB. It has also been uploaded and activated in the 699B07 using the previous section. The following instructions detail usage of the 699B07 while the pre-programmed test is active. To use the 699B07 in manual mode again the calibration route must be de-activated (see next section).

- With a Calibration Route active the 699B07 will only cycle to the pre-programmed test points. The **FREQUENCY** dial can be used to cycle and preview test points without saving data.
- Pressing the amplitude dial will not change amplitude scales while route is active.
- Data is still stored to internal memory when Calibration Route is active if **FILE** dial is pressed while “Save Point” is displayed. Delete, Save, Tools and End Record functions operate as previously detailed in “Basic Operation” section.

- Step 1** Once the Calibration Route is activated shaker will vibrate at first pre-programmed test point. Use **FILE** dial to display “Save Point” then press the dial.
- Step 2** A pass/fail indication is displayed. The frequency, amplitude, sensitivity of sensor under test, upper and lower bounds are shown. If sensitivity is between upper and lower bounds “Pass” is shown at top right. If sensitivity is outside of bounds “Fail” is displayed. Press **FILE** dial to continue to next test point.
 - Step 2a** If test point fails technician can delete the point and try again by using **FILE** dial to display “Delete” then press and make appropriate selection. Deleting the point will step the test back to the previously failed test point.

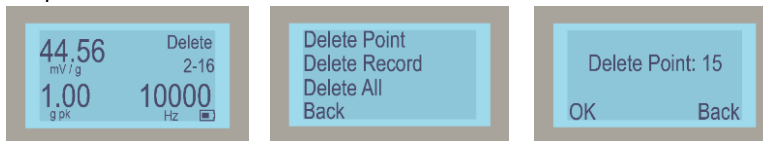

- Step 3** Continue the test point-by-point by pressing the **FILE** dial with “Save Point” displayed. The pass/fail screen will appear after each point.
- Step 4** When test is complete the model and serial number entry screen is displayed. Enter data as outlined in “Basic Operation” section or skip by pressing **FILE** with “Next” displayed.

Step 5 A final data entry screen is displayed, with “Save” displayed press FILE to save the calibration test results to internal memory and begin next test.

Creation of print-able test reports is done as previously mentioned. Follow instructions in “Basic Operation” section to create frequency response and linearity calibration certificates in Microsoft Excel®.

Route Option Menu

The Route Option menu is accessed by pressing **FREQUENCY** dial then using the dial to highlight and click on **Test Settings**, then using the dial to highlight the text next to **Cal Route:** and clicking on it. The menu has the following functionality and the **FREQUENCY** dial is used to navigate and select:

- **Back** – returns to Test Settings menu
- **Activate Route** – activates the calibration test stored in memory
- **Deactivate Route** – returns the 699B07 to manual operation, de-activates semi-automated test
- **Load File From USB** – shows a list of up to six pre-programmed tests (routes) read from Calibration_Route folder on USB drive
- **Delete Route** – returns the 699B07 to manual operation and also deletes the pre-programmed test from memory
- **File Information** – displays name of semi-automated test, number of test points and date it was created. If no test is active pressing file while this option is highlighted does nothing.
- **Eject USB** – allows user to safely remove the USB drive from 699B07

2.4 Charge Mode Operation

The Model 699B07 is capable of creating calibration reports for charge mode sensors where the output is in pico-coulombs (pC) per engineering unit (g’s of acceleration, inches per second, etc.). An external charge amplifier or charge converter is required. It is best practice for the charge converter/amplifier to be calibrated, as this will allow for the minimum uncertainty when calibrating the vibration transducer. PCB Piezotronics offers accredited charge converter/amplifier calibration services.

Selecting Charge Mode Sensor Type & Entering the Conversion Value

Step 1 Press the **FREQUENCY** dial to enter “Calibration Options” menu, rotate to highlight **TEST SETTINGS** and press again to enter “Test Settings” menu.

Step 2 Use **FREQUENCY** dial to highlight and click selection next to “Sensor Type:”. Selection will be “ICP®”, “Voltage”, “Charge”, or “Mod Cur” depending upon previous status. Press the **FREQUENCY** dial to toggle until “Charge” is selected. Exit the menu using the **FREQUENCY** dial to highlight the word “Back” and click twice to return to manual operation. The sensitivity display will now show pC/EU.

Step 3 Rotate the **FILE** dial until the word “Tools” appears at top right of the screen then press **FILE** to enter into the Tools menu.

Step 4 Use the **FILE** dial to highlight “Options” and click to enter the Options menu.

Step 5 Use the **FILE** dial to highlight and click on “Charge Amp Factor”. The display will show the last input charge amplifier conversion factor in mV/pC. If this is still correct, use the **FILE** dial to highlight the word “Back” and exit. If the value needs to be changed, use the **FILE** dial to highlight the word “Adjust” and click.

Step 5a When “Adjust” is selected the display will show 000.000 mV/pC and the cursor will be in the hundreds place. Turn the **AMPLITUDE** dial to change each digit until the correct value is shown then press the

FREQUENCY dial to advance to the next digit until all six digits are correct. For example, when programming for a 10 mV/pC charge amplifier, use the dials to program 010.000 mV/pC. After the final digit is confirmed the unit will return to the manual shaker home screen.

toggling ICP® Power for the Charge Converter

Some charge amplifiers/converters require ICP® power such as PCB's Series 422. ICP® power is available on the Test Sensor Input BNC of the 699B07. Other charge amplifiers – most commonly found in power generation to convert signals from high-temp on-turbine vibration sensors – utilize 18-30 VDC for power. Thus, depending upon the test setup users may or may not wish to have ICP® power supplied by the 699B07.

To toggle ICP® power on/off, from the shaker home screen, rotate the **FILE** dial until the word “Tools” is displayed at top right, then click **FILE**. Use the **FILE** dial to highlight the word “Options” and click again. Next use **FILE** to highlight and click on “ICP® Power for Charge”. The ICP® Power for Charge submenu is shown and the current selection – Enable or Disable – is highlighted. To **ENABLE** ICP® power press the **AMPLITUDE** dial. To **DISABLE** ICP® power press the **FREQUENCY** dial. After a selection is made the 699B07 returns to the Options menu.

Optional Charge Mode Sensor Testing Accessories

Users who have differential charge mode vibration sensors have the option to purchase PCB Piezotronics accessories for calibration. Differential charge mode sensors are typically used on heavy-duty gas turbines in power generation applications. Users may wish to calibrate these critical sensors with a charge amplifier that has been calibrated to three decimal places.

Commonly requested optional accessories are:

- PCB Piezotronics Model 422E02 charge amplifier calibrated to three decimal places, nominal sensitivity of 10 mV/pC
- PCB Piezotronics Model 045ET002AC, 7/16-27 2-socket MIL cable, 2 ft., to BNC plug termination
- PCB Piezotronics Model 012A03, BNC male to BNC male cable, 3ft, for connection to 699B07
- PCB Piezotronics Model 070A03, 10-32 plug to BNC jack scope input adaptor for input to 422E02

2.5 Modulated Current

Most vibration sensors are voltage output but some are AC current output, typically found in high-temp or long cable length applications. The Modulated Current firmware option adds capability to display sensitivity on 699B07 in $\mu\text{A}/\text{EU}$. An external signal conditioner is needed for this feature. Please contact PCB for more information.

Selecting Modulated Current Sensor Type

Modulated Current sensor type can be selected two ways:

- Step 1** Press and hold the **AMPLITUDE** dial until **Sensor Type: Mod Cur** appears on display. This may have to be done more than once as unit cycles from ICP® to Voltage to Charge to Mod Cur.
- Step 2** Press the **FREQUENCY** dial to enter into Calibration Options. Use **FREQUENCY** dial to highlight and click on **Test Settings** then use same dial to highlight selection next to **Sensor Type:** and press to toggle from ICP® to Voltage to **Mod Cur**.

Adjusting the Resistance Value

Modulated current vibration sensors are read by the 699B07 across a precision resistor. The resistance value in 699B07 is set to 500 ohms by default. This value is critical to calibration accuracy for modulated current sensors. To change the value...

- Step 1** Rotate the **FILE** dial until **Tools** is displayed at top right then press the dial
- Step 2** Use **FILE** dial to enter the **Options** menu
- Step 3** Use **FILE** dial to select Set Resistance Value
- Step 4** Use **FILE** dial to select **Adjust**
- Step 5** Display will show "000.00 Ohms". Use **AMPLITUDE** dial to change value one digit at a time starting with the most significant digit. Press **FREQUENCY** to confirm and move to the next digit.
- Step 6** When all five digits have been confirmed 699B07 will exit to normal operation.

2.6 Definition of Frequency Units

- Hertz (Hz) is defined as the number of periodic cycles per second and it is a standard unit for measuring signal frequency.
- CPM stands for Cycles Per Minute. CPM is commonly used for testing industrial sensors that monitor rotational vibration. 1 Hz=60 CPM

2.7 Definition of Amplitude Units

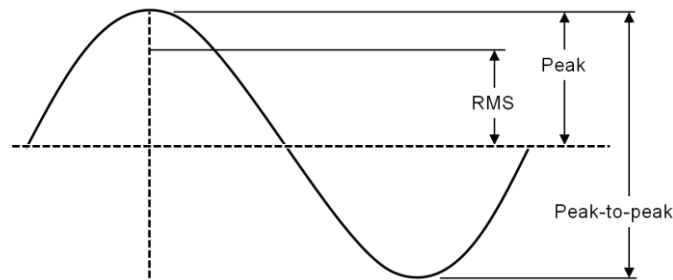

Figure: Sinusoidal Wave

- Root Mean Square (RMS) is a calculation that takes the square root of the average of the squared amplitudes from a set of data. This type of measurement takes all amplitudes of a signal into account rather than just one, making it an accurate tool for an overall calculation.
- Peak (pk) bases calculations on the highest value of the signal generated during testing. For a sinusoidal wave (as is produced by the 699B07), the peak value is calculated by $RMS \cdot \sqrt{2}$. The 699B07 does not measure a true peak value, but instead estimates the value mathematically based upon the RMS value.
- Peak to Peak (p-p) is a calculation of the difference between the highest positive peak and the lowest negative peak of a recorded sine wave. The p-p value is calculated as two times the peak value.
- Gravitational acceleration (g) is the acceleration experienced naturally by objects in earth's gravitational field. It is approximately equal to 9.80665 m/s^2 .

2.8 Mounting Basics

Connecting Sensor to 699B07 Platform

- Step 1** Mating surfaces of the mounting platform and sensor should be flat, parallel and free of dirt, paint, epoxy, scratches, etc.
- Step 2** Threads in platform, sensor and adaptor (if needed) must match to ensure a proper fit and that testing is free of errors. Clean any worn threads with a tap or die and coat them in silicone grease for best results.
- Step 3** An adaptor may be needed to connect the sensor to the armature. The 699B07 platform requires a ¼-28 thread.
- Step 4** Silicone grease can be applied to the mating surfaces and threads to ensure good mechanical coupling. This is particularly important when testing at high frequencies.
- Step 5** For threaded sensors, please follow the sensor manufacturer's torque recommendation.

Tightening and Loosening Connections

- Step 1** When tightening or loosening the connection between the sensor and the 699B07 mounting platform, secure the mounting platform with the supplied wrench.
- Step 2** It is important to keep sensors and fixtures centered and straight when attaching them to the 699B07 mounting platform. This will ensure a stable, even connection and eliminate potential alignment issues.

2.9 Input / Output

EXTERNAL SOURCE IN Input BNC

It is possible to drive the 699B07 by using an external signal source or a function generator. First, connect a signal source to the **EXTERNAL SOURCE IN** BNC Input located on the top left corner of the unit. To enable the **EXTERNAL SOURCE IN** input, press the **FREQUENCY** dial to enter the "Calibration Options" menu then rotate **FREQUENCY** dial to highlight and click on **TEST SETTINGS**. Next, use **FREQUENCY** dial to highlight selection next to "Source:" and toggle between "Internal" and "External" by pressing the dial, select "External".

- Step 1** When in **Ext Sig** mode, the vibration amplitude is measured and displayed on the screen, however, the frequency and amplitude of the shaker is controlled by the external source, not by the 699B07. The frequency of the input signal is not displayed on this mode.
- Step 2** The amplitude and sensitivity values displayed on the screen are for reference only. The measurements are not accurate while in **Ext Sig** mode and do not fall under the published specifications for the product.



Do not exceed 1V RMS! Overdriving the unit may cause clipping, unwanted distortion and damage to the unit.

MONITOR REFERENCE OUT Output BNC

The 699B07 is controlled by an internal shear mode quartz reference accelerometer. The voltage output of the reference accelerometer can be monitored through the available Monitor Reference BNC Output by connecting it to a readout device (e.g. voltmeter or oscilloscope). The nominal sensitivity is 10 mV/g. The exact sensitivity is noted on the calibration certificate of the 699B07.

Diagnostic Screen

The diagnostic screen can be displayed by holding down the file button for approximately 2 seconds. This screen displays information about the operation of the 699B07. The information found in this menu is displayed in real time:

- Reference ICP® Bias Voltage
- Test Sensor Bias Voltage
- Test Sensor Type: Voltage, ICP® or Modulated Current
- Signal Type: Internal or External
- Reference THD
- Sensor THD

Exit the diagnostic screen by pressing the file button.

TEST SENSOR IN Input BNC

The 699B07 provides the capability to measure the test sensor's voltage signal, replacing the need for an external DMM or data acquisition. The input electronics can be configured for Voltage, ICP®, Charge Mode or Modulated Current mode as described in Step 4 of Basic Operation earlier in this manual.

The **TEST SENSOR IN** input BNC is capable of measuring a voltage input of up to 10V AC pk-pk. As an ICP® sensor signal conditioner, it measures up to 10V pk-pk AC signal while supplying 5mA ICP® constant current at 25V DC. While in ICP® mode, the input circuit is also monitoring the ICP® sensor Bias Voltage and will indicate a Bias Fault when the DC voltage is below 2V DC or above 15V DC. The open circuit voltage of the ICP® supply will be 25V DC. This open circuit and the ICP® Bias Voltage may be checked using the diagnostic menu.

USB Connection

The USB connection on the 699B07 serves three purposes:

- The USB connection serves as a power source for optional power supply accessories. Please contact PCB for more information.
- It is used with the supplied USB flash memory drive to upload CALROUTE pre-programmed tests into the 699B07.
- Lastly, the USB connection is used to export calibration records from the memory of the 699B07 onto the supplied USB flash memory drive.

It is also used during the manufacturing and calibration processes.

3. THEORY OF OPERATION

3.1 Instrumentation

The Model 699B07 Portable Vibration Calibrator internal electrical system is comprised of several different mechanisms:

- Electrodynamic Shaker
- Power Amplifier
- Reference Accelerometer
- Signal Generation Electronics
- Sensor Signal Measurement Electronics
- LCD Digital Display
- Dials with Detent and Integrated Pushbuttons
- 12 VDC, 4 Amp Hr Solid Gel Battery
- External Charger
- Three different BNC ports: “External Source In,” “Monitor Reference Out” and “Test Sensor In”
- USB Flash Drive Port

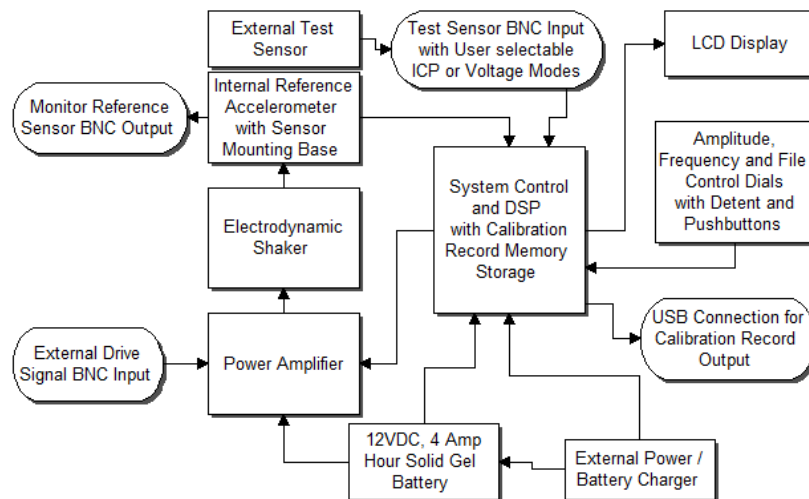

The LCD display continuously shows the frequency of the shaker drive signal and the vibration amplitude of the mounting platform as measured by the reference accelerometer.

The reference accelerometer is a PCB Piezotronics ICP® quartz shear sensor, integrated into the mounting platform. A calibration “standard” is used to calibrate the 699B07 as a complete system and provides NIST traceability. Traceability information can be viewed under the tools menu as described in the previous section.

The power amplifier is specifically designed to provide the current required to drive the electrodynamic shaker. The electronic signal processing system produces a variable frequency sine wave to the power amplifier, which becomes the source of the driving signal to produce the vibration at the mounting platform.

The frequency of the shaker drive signal is controlled by the front panel **FREQUENCY** dial. The amplitude of the shaker drive signal is controlled through a feedback loop, to maintain the stability of the actual motion. Adjusting the front panel **AMPLITUDE** dial adjusts the target vibration amplitude.

Pressing the **AMPLITUDE** dial toggles the amplitude measurement units through the following choices if all units are active:

ACCELERATION	VELOCITY	DISPLACEMENT
g pk	In/s pk	Mils p-p
g RMS	In/s RMS	µm p-p
m/s ² pk	mm/s pk	
m/s ² RMS	mm/s RMS	

Users can de-activate amplitude scales by using the “Amplitude Units” menu. See the section “Amplitude Units” for more information. If desired scale is not appearing while pressing **AMPLITUDE** to cycle through scales, then it has likely been turned off in the “Amplitude Units” menu.

Turning the **FILE** dial activates the file menu. Turn the **FILE** dial to toggle between the below options and press the dial again to select.

SAVE POINT	END RECORD	DELETE	TOOLS
	Next	Delete Point	USB Menu
	Edit	Delete Record	Options
	Back	Delete All	Traceability
		Back	Back

Below are the options to choose from when the USB Menu is selected. Turn the **FILE** dial to the proper option and press it to select.

COPY ALL RECORDS	MOVE ALL RECORDS	USB OPTIONS
		Eject
		Format USB
		Back

Below are the options to choose from when the Options menu is selected. Turn the **FILE** dial to the proper option and press it to select.

DATE & TIME	CALIBRATION INTERVAL	SET CALIBRATION VALUE
Adjust	Adjust	Adjust
Back	Back	Back

Pressing and holding the file button will return to the main calibration screen from any new level.

3.2 Battery & Charger

The Model 699B07 can be operated from AC line power or from its internal rechargeable battery. When the external power supply is connected, it becomes the primary power source, operating the unit while simultaneously charging the battery.

NOTE: It is good practice to perform calibrations on battery power. Disconnecting from line power ensures a power surge will not cause the calibrator to power down during test. If excess current is detected during use, the portable calibrator shuts down to prevent damage.

Battery power is supplied by a sealed solid gel lead acid 12 VDC rechargeable battery. The battery can be permanently damaged if completely drained. To prevent damage, the 699B07 will automatically shut off when the battery power level gets too low. *Suggested Best Practice: Keeping the battery fully charged ensures the unit is always ready for use.*

Under mild operating conditions (lower mass transducers at lower test amplitudes), a fully charged battery will allow the 699B07 to operate for up to 18 hours. The charge life of the battery depends on both the length of use and the amount of power (dependent upon payload, frequency and amplitude) required for a particular test. When testing requires high vibration levels, the charge life will be shorter than during less rigorous testing. For example, continuous testing of 100 gram payload at 10 g pk will drain the battery charge in approximately 1 hour.

A Battery Charge Indicator is displayed on the LCD screen to approximate the unit's remaining charge life. Replacement batteries (Model 600A26) and power supplies/chargers (Model Number 600A25) are available from PCB Piezotronics.

The 699B07 calibrators continuously monitor the state of battery charge during operation, storage and charging. During operation, if the battery capacity falls near minimum, the unit will shut off after approximately 2 minutes of inactivity rather than the usual 20 minutes. During storage, if the battery voltage falls near the minimum, the unit will go into deep sleep, requiring connection of AC power and reset of time and date before resumption of operation. During charging, the unit continuously displays charging indication and state of charge, depending upon operation level and time of charge.

Battery Information and Care



- The unit is delivered in a partially charged state. Fully charge unit for 20 hours before using for the first time. (The unit cannot be overcharged by keeping it plugged into the power supply.)
- To recharge the unit, use only the universal power supply included. All batteries lose energy from self-discharge over time and more rapidly at higher temperatures. A full charge cycle can take up to 20 hours.
- If not used for a prolonged period of time, recharge every 2 months.
- **Suggested Best Practice:** Charge unit fully prior to field use. Recharge the unit as soon as possible after use.

4. SPECIFICATIONS & PERFORMANCE

MODEL 699B07 SPECIFICATIONS		
PERFORMANCE	US	SI
Frequency Range (operating)	5 Hz – 10 kHz	300 to 600k CPM
MAXIMUM AMPLITUDE (50 HZ, 10 GRAM PAYLOAD)		
Acceleration	20 g pk	196 m/s ² pk
Velocity	20 in/s pk	500 mm/s pk
Displacement	150 mils pk – pk	3.8 mm pk – pk
Maximum Payload ^[1]	800 grams	
ACCURACY OF READOUT^[2]		
Acceleration (10 Hz to 10 kHz)	± 3% ^[3]	
Acceleration (5 Hz to 10 Hz)	± 5% ^[3]	
Velocity (10 Hz to 1000 Hz)	± 3%	
Displacement (30 Hz to 150 Hz)	± 3%	
Amplitude Linearity (100 gram payload, 100 Hz)	< 1% up to 10 g pk	
Waveform Distortion (100 gram payload, 30 Hz to 2 kHz)	< 5% THD (typical) up to 5 g pk	
UNITS OF READOUT		
Acceleration (peak/RMS)	g	m/s ²
Velocity (peak/RMS)	in/s	mm/s
Displacement (peak to peak)	mils	µm
Frequency	Hz	CPM
Test Sensor Sensitivity	mV/EU ^[4] , pC/EU, µA/EU, mA/EU	
PHYSICAL		
Test Sensor In	Voltage, Charge, Modulated Current or ICP [®]	
Bias Fault Indication (ICP [®] Sensors)	Yes	
External Source In (max.)	1 VAC RMS	
Monitor Reference Out	10 mV/g (nominal), buffered internal reference	
Internal Battery (sealed gel lead acid)	12 VDC, 4 amp hours	
AC Power (for recharging battery)	110 – 240 VAC, 50 - 60 Hz	
Input Power Rating from charger	18 VDC, 1 A	
OPERATING BATTERY LIFE^[5]		
100 gram payload, 100 Hz, 1 g pk	18 hours	
100 gram payload, 100 Hz, 10 g pk	1 hour	
Memory Size	Up to 500 calibration records	
Points Per Record	30 calibration data points	
Sensor Information	Model number, serial number, sensitivity direction (x, y, z), user notes	
USB Port	Export to flash drive (FAT32)	
Export File Format	CSV (comma-separated values)	

MODEL 699B07 SPECIFICATIONS (CONTINUED)

PHYSICAL (CONT.)		
Operating Temperature	32° - 122°F	0° - 50°C
Dimensions (H x W x D)	8.5 x 12 x 10 in	22 x 30.5 x 28 cm
Weight	18 lbs	8.2 kg
Sensor Mounting Platform Thread Size	¼ - 28	
SHAKER LOADING		
SUT Input Voltage Range	10V AC pk-pk	
SUT ICP® Current	5 mA	
SUT Bias Offset Measurement Range	0-25 V DC	
SUT Bias Fault Voltage Limits	2V / 15V DC	

Notes:

[1] Operating range reduced at higher payloads. Reference shaker loading curves for full details

[2] Measured with 10 gram quartz reference accelerometer

[3] Calculated by measuring the % difference between the known sensitivity of a reference accelerometer as calibrated by laser primary system per ISO 16063-11 and the measured sensitivity of same reference accelerometer when tested at the same points.

[4] EU can be [g], [m/s²], [in/s], [mm/s], [mils] or [µm].

[5] As shipped from factory in new condition

Maximum advisable vibration levels are dependent upon the maximum frequency of operation and the payload. The chart below shows the maximum vibration levels as a function of both frequency and payloads. Payloads exceeding 800 gram should not be tested on the Model 699B07.

Excessive loads may result in damage to the moving coil and flexure. Care must be taken when testing payloads with large footprints, particularly those with an offset center of gravity. Severe rocking modes can produce high transverse motion and lateral loads on the moving coil and flexure, resulting in damage. When fitting test transducers and fixtures onto the mounting platform, aim to keep the center of gravity directly above, and in line with the center axis of the ¼-28 threaded hole. This is a safeguard against side loading the shaker.

In some cases of extremely heavy shaker payloads at high vibration levels (depending on the frequency), the 699B07 may exhibit both frequency and amplitude instabilities. In this case, please reduce the excitation amplitude and/or the payload to eliminate the effect.

The 699B07 electronics incorporates a shaker power amplifier with thermal protection. If the shaker payload amplitude and run time exceed safe thermal ranges, the shaker table power amplifier will protect itself and shut off. The unit should be turned off and allowed to cool before resuming operation.

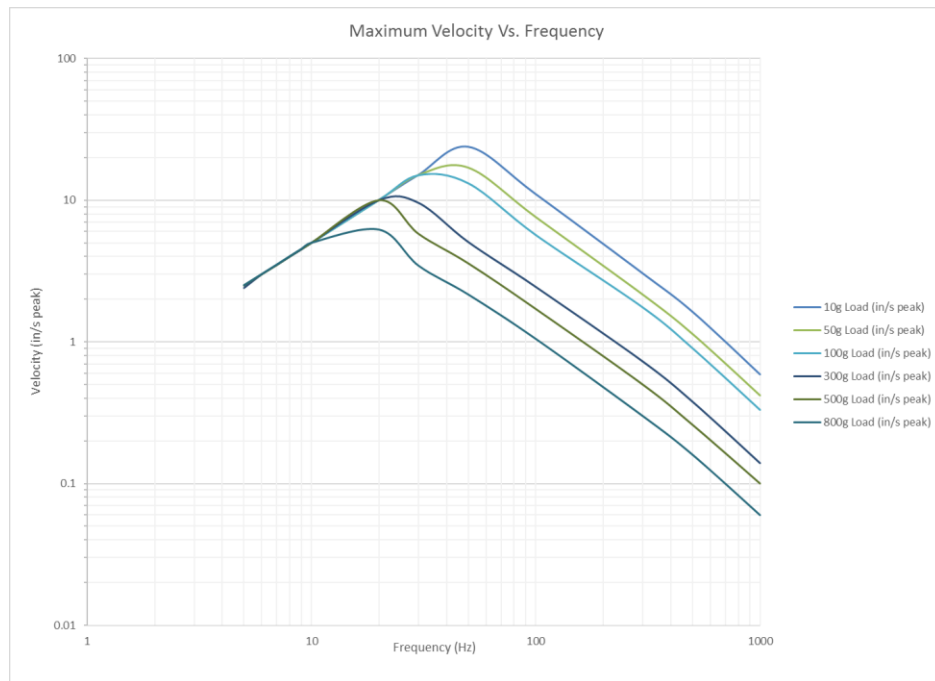
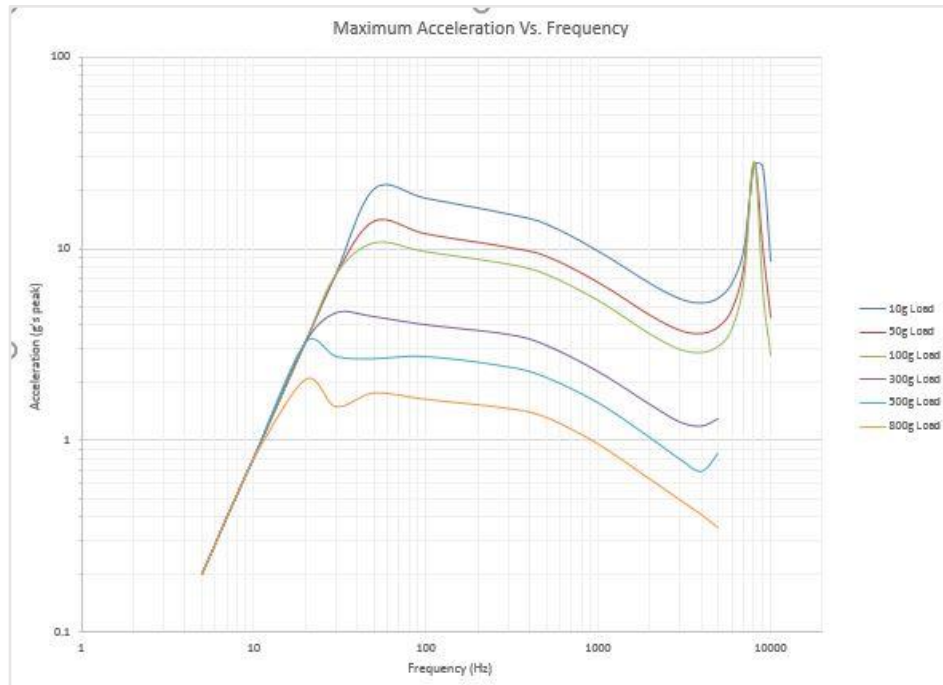

5. RECOMMENDED PRACTICES

5.1 Testing the Internal Reference Accelerometer for Drift

Checking for drift of the internal reference accelerometer inside the portable vibration calibrator is an ideal way to quickly ensure the accuracy of the device. The sensitivity of the reference accelerometer (10 mV/g nominal) should remain very close to its original calibrated sensitivity provided on the device's calibration certificate. Also, this measurement should be stable. If the voltage measurement is fluctuating, it could indicate a damaged shaker.

To perform this test technicians should obtain the following:

- Calibrated digital voltmeter set to measure mV AC
- BNC male to BNC male cable. Available through PCB Piezotronics. Cable series: 012A, 002D, 003D all work equally well. Cables can be any length but ideally less than 10 ft. (3m).
- BNC female to double banana plug (Pomona Model 1269). Makes connection to voltmeter easy.

Procedure:

1. Turn on the Portable Vibration Calibrator
2. Set the calibrator to **1.00 g rms at 100 Hz**
3. Connect the voltmeter to the **MONITOR REFERENCE OUT** using the BNC-BNC cable and double banana plug and measure **mV AC**
4. Check the Internal Reference Sensitivity at 100 Hz on the last Calibration Certificate for the device.

The measured voltage represents the sensitivity of the Internal ICP® quartz internal reference accelerometer. It should be within $\pm 3\%$ of the original calibrated sensitivity at 100 Hz. If it is outside of the +/- 3% tolerance users should send the portable vibration calibrator back to PCB for re-calibration and adjustment. Re-calibration and adjustment due to drift are covered under the two-year warranty.

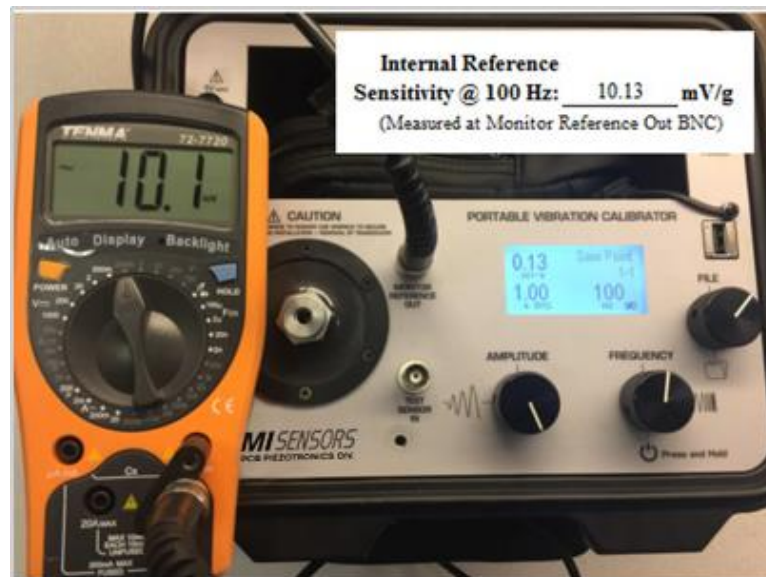

5.2 Operational Verification & Recalibration

As with all calibration systems, periodic verification of the system's performance is strongly recommended. This is best done by calibrating a dedicated verification accelerometer each day that the unit will be used. This practice confirms proper calibration of the equipment at the time of use. A precision accelerometer with a quartz sensing element is recommended for performing operational verification.

Results of the verification should be compared to previous results obtained with that dedicated, controlled accelerometer. If the calibration result of the verification sensor changes, the 699B07 should be evaluated further to determine the root cause of the discrepancy.

Field repair of the 699B07 is not possible, so if performance of the 699B07 is out of specification, it should be sent back to PCB Piezotronics for evaluation, repair and recalibration. Please contact PCB at info@pcb.com or 800.828.8840 for a Return of Material Authorization (RMA) number.

5.3 Standard Checks for Transducers

Linearity and frequency response checks should be performed periodically to validate vibration transducer functionality.

Linearity is checked by submitting the sensor to different vibration levels while frequency is kept constant (typically at 100 Hz or any other frequency specified by the transducer's manufacturer). The vibration is set to different levels within the dynamic range of the sensor, trying to cover (as much as possible) from low to high operating levels. The sensor output is recorded and checked if it remains proportional (linear) to the sensor excitation input. Alternatively, the sensor sensitivity can also be recorded and its deviation observed for the different test points (it should not vary too much for sensors that are linear).

The frequency response of a vibration transducer can be tested by checking the sensor output across different frequency points within the operational frequency range of the transducer. Typically, the vibration level of the unit is set at a constant value (10m/s² and 1g are common choices for accelerometers) and the sensor output (or the sensor sensitivity) is observed and recorded at different frequency points.

5.4 Typical Accelerometer & Velocity Sensor Checkout

Accelerometers & velocity sensors are tested by performing a frequency response calibration. This is done by measuring the sensitivity of the sensor at a variety of frequencies within its linear range. Per the ISO 16063-21 accelerometer calibration standard, the amplitude at each frequency is at the discretion of the user and need not be kept consistent. Best practice is to use amplitude safely above the noise floor and but low enough not to create distortion on the shaker. Thus 1.0 g's peak is the most common amplitude used for 100 mV/g accelerometers.

The ISO 16063-21 standard recommends testing at the center frequencies of the 1/3 octave bands. For accelerometers with 10 kHz high frequency response that would mean 29 different test points, which can be time consuming. Accelerometer manufacturers test at far less points. In general as long as the test covers the practical usage of the sensor and the test points are evenly dispersed through the test range the user will perform a good and thorough test of an accelerometer.

A good practice within industrial applications is to follow the American Petroleum Institute Standard 670 "Machinery Protection Systems" recommendations for accelerometer and velocity sensor test points. Standard 670 recommends testing at the following frequencies for both accelerometers and velocity sensors:

- 10, 20, 50, 61.44, 100, 200, 500, 1000, 2000, 5000 and 10000 Hz
 - Model 699B07 is not capable of 61.44 Hz, only integer numbers such as 61 or 62.

For accelerometers the recommended amplitudes in API 670 are:

- 0.15 g's peak (1 m/sec² RMS) for 10 Hz
- 1 g peak (7 m/sec² RMS) for 20-1000 Hz
- 4 g's peak (30 m/sec² RMS) for 2000-10000 Hz

For velocity sensors the recommended amplitudes in API 670 are:

- 0.92 ips peak (15.92 mm/sec RMS) for 10 Hz
- 3.08 ips peak (55.70 mm/sec RMS) for 20 Hz
- 1.23 ips peak (22.28 mm/sec RMS) for 50 Hz
- 0.62 ips peak (11.14 mm/sec RMS) for 100 Hz
- 0.31 ips peak (5.57 mm/sec RMS) for 200 Hz
- 0.12 ips peak (2.23 mm/sec RMS) for 500 Hz
- 0.06 ips peak (1.11 mm/sec RMS) for 1000 Hz
- 0.12 ips peak (2.39 mm/sec RMS) for 2000 Hz
- 0.05 ips peak (0.95 mm/sec RMS) for 5000 Hz
- 0.02 ips peak (0.48 mm/sec RMS) for 1000 Hz
 - Note that velocity is not recommended as a vibration measurement scale at frequencies greater than 1000 Hz. Thus many sensor manufacturers install low-pass filters on velocity sensors at 1000 Hz or lower.

Practical Industrial (Predictive Maintenance) Testing Recommendations

While testing to the API 670 or ISO 16063-21 standard is certainly thorough it is not always practical and is time consuming especially for the predictive maintenance user. Thus PCB Piezotronics makes the following recommendations for industrial vibration:

- For permanent mount accelerometers/velocity sensors routed to an online monitoring system or junction box, at least test the sensors at 1x and 2x running speed and confirm both the vibration alert (high) and alarm (high-high).
- For route-based predictive maintenance where one sensor is magnetically mounted on many machines at many points, perform a complete frequency response test of the accelerometer. Its accuracy is important at many frequencies. Test to Fmax on the vibration analyzer. If high frequency bearing fault detection methodologies are in use, test the sensor to the highest possible bearing defect frequency.
 - Tip: magnetically mounting sensors greatly reduces high frequency response. Two ferrous magnet target, mounting pads, 600A54 and 600A55, are included with the 699B07. One can install this pad on the shaker and mount accelerometers magnetically. Always rock the sensor in place as one would on the machine. Test the accelerometer to Fmax on the analyzer to see if response is amplified at relevant high frequencies.

5.5 Non-Contact Displacement Sensor Calibration

Non-contact displacement sensors, also known as proximity probes, eddy current probes or displacement probes, can be checked for accuracy, linearity, and frequency response. Proximity probe systems require the use of the optional 600B22 (or 600B23) proximity probe adaptor kit.. The following sections detail the procedure for performing linearity and frequency response checks on a non-contact displacement sensor.

Models 600B22 & 600B23

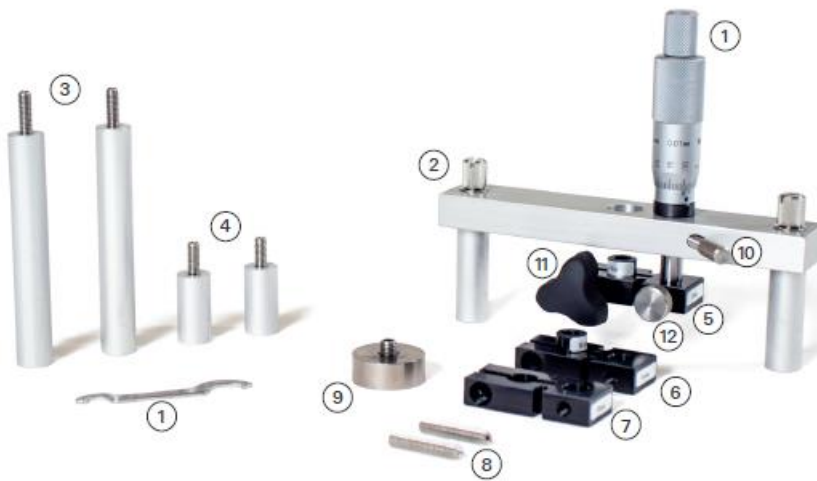

699B06/699B07

Proximity Probe Adaptor Kit

Model 600B22 (Imperial)

Model 600B23 (Metric)

- ① Micrometer Barrel (and wrench)
- ② Probe Bar (with attached 1 1/2 in spacers)
- ③ 3 1/4 in Spacer (QTY 2)
(10-32 set screws shown installed)
- ④ 1 in Spacer (QTY 2)
(10-32 set screws shown installed)
- ⑤ 8 mm Probe Bracket (with 6 mm reducer)
- ⑥ 3/8 in Probe Bracket (with 1/4 in reducer)
- ⑦ 10 mm Probe Bracket
- ⑧ 10-32 x 1 in Set Screws (QTY 6)
- ⑨ AISI 4140 Steel Target
(with 1/4-28 set screw)
- ⑩ Narrow 10-32 Thumb Screw (QTY 2)
- ⑪ 10-32 Three Arm Knob
- ⑫ 10-32 Thumb Screw

IMI SENSORS
A PCB PIEZOTRONICS DIV.

DS-0168 revA

5.6 Non-Contact Displacement Sensor Test Setup

Note: The calculations in these instructions are based on a 200 mV/mil eddy current proximity probe to provide an example based on nominal sensitivity. In most cases, the proper proximity probe, extension cable, and driver (proximitor®) must be matched in order to obtain the expected output from this type of transducer.

[Proximitor is a registered trademark of Bently Nevada.]

- Step 1** Remove the (2) 10-32 pan head screws on the user panel of the portable vibration calibrator (white arrows in picture below).



- Step 2** Install the AISI 4140 steel target into the shaker on the mounting platform.



Step 3 Install the non-contact displacement sensor in the microarm after stringing the probe through the probe bar as shown in the picture below. Please note: An 8 mm probe tip non-contact displacement sensor with 3/8-24 threaded case will mount directly while a 5 probe tip mm non-contact displacement sensor with a 1/4-28 threaded case requires the supplied bushing. Slide the non-contact displacement sensor into the microarm. Tighten the socket head cap screw inside the microarm to lightly squeeze the probe to ensure the probe is held securely.

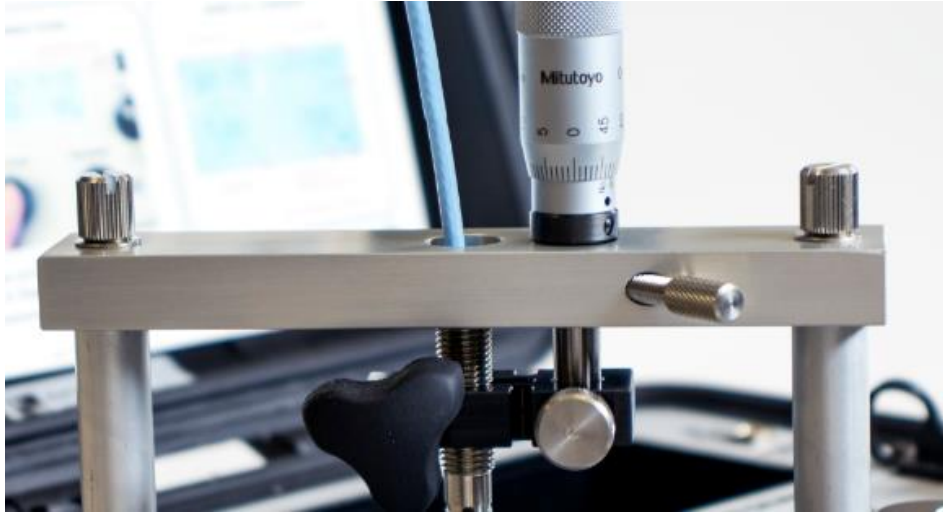

Step 4 Carefully lay out the assembly to resolve the required spacer or spacers to hold the non-contact displacement sensor the proper distance from the target as shown below. The non-contact displacement sensor will need to be held so that the sensor will contact the target and must be capable of traveling 100 mils before the micrometer runs out of travel. (for 200 mV/mil probe with 10-90 mils range). Non-contact displacement sensors come in various lengths so adjustability has been designed into the assembly. Attach selected spacer or spacers using setscrews provided, leaving threaded holes exposed.

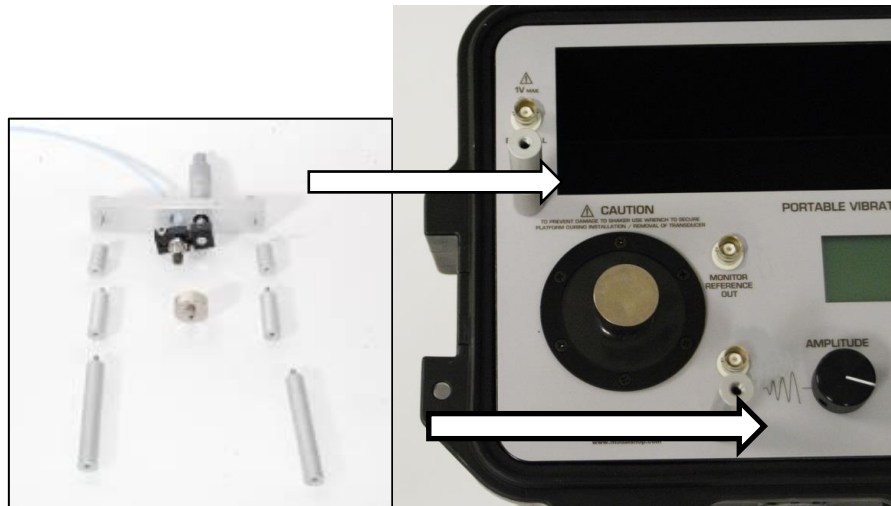

Step 5 Finalize the assembly by attaching probe bar, microarm, non-contact displacement sensor, and micrometer on top of the spacers and secure with provided panel screws.



5.7 Proximity Probe Dynamic Linearity Calibration & Confirmation of Vibration Alarms

IMPORTANT: The 699B07 powers up at the unit's previous frequency and amplitude settings. Prior to using the 699B07 for calibrating non-contact displacement sensors, set amplitude to a low level to avoid striking the tip of the probe with the target due to previously set large displacements.

- Step 1** **Mount** the proximity probe to the shaker facing the target by following instructions in the previous section.
- Step 2** **2. Gap the probe.** With the non-contact displacement sensor powered up and the output from the probe driver wired to a voltmeter set to DC voltage, adjust the micrometer so the gap between the probe tip and the steel target is around 50 mils. If you are using a 200 mV/mil proximity probe the voltmeter should read between -8 and -11 Volts DC, typically ~-9 Volts DC is 50 mils. Fifty mils is the typical recommended gap setting for non-contact displacement sensors, ensuring the sensor is in the center of its dynamic range. If the probe is 50 mils from target (or rotating equipment before start-up) it can accurately measure up to 80 mils peak-to-peak vibration. Consult your non-contact displacement sensor's user manual for additional information.

Step 3 Power-on the shaker by pressing and holding the **FREQUENCY** dial.

Step 4 Test the probe at running speed of the machinery it protects. Primary vibration issues occur at running speed. Thus ensuring the proximity probe is accurate at running speed is the most practical and confidence-building test. Test speed can be set in Hz or CPM (see Section 2: Operation Guide for instructions) by turning the **FREQUENCY** dial.

Step 5 Confirm vibration alarms. Press the **AMPLITUDE** dial to cycle through vibration scales until either mils p-p or μm p-p is displayed. Choose the appropriate scale for your vibration monitoring system. Turn the **AMPLITUDE** dial, adjusting vibration to the lowest vibration alarm threshold (sometimes called “alert”). Confirm with control room that displayed amplitude on model 699B07 shaker equals value read on monitoring system. Confirm vibration alarm is triggered, making sure to wait long enough for programmed time delays to expire. Repeat the process for each vibration alarm threshold.

Step 6 Create a linearity test report for auditing purposes. Connect the output of the probe driver to the **TEST SENSOR INPUT** BNC. Make sure model 699B07 is in “voltage mode” by pressing and holding the **AMPLITUDE** dial or using the **TEST SETTINGS MENU**. Sensitivity of the probe, extension cable and driver is at top left of the LCD screen. Keep the same speed throughout this test, ideally running speed of the machine on which the probe is installed. Use the **AMPLITUDE** dial to adjust vibration displacement level. The typical test is from 1.0 to 10.0 mils p-p, recording sensitivity every 1.0 mils (1.0, 2.0, 3.0 mils pk-pk, etc.). The test can be modified to suit the needs of the application. To save each test point to memory rotate the **FILE** dial until **SAVE POINT** appears at top right, then press the **FILE** dial to save data to memory. When complete, rotate **FILE** dial to display **END RECORD** then press **FILE** dial.

- i) *Note: if “Bias Fault” appears at top left on display the 699B07 is supplying ICP® power to the proximity probe. This will not damage the probe. But ICP® power must be turned off by pressing and holding the **AMPLITUDE** dial.*
- ii) *Note 2: Visit pcb.com for helpful videos*

Step 7 Export the test(s) to the supplied USB drive. For detailed instructions see Section 2: Operation Guide

Step 8 Create, save and print test report using Microsoft® Excel®. Connect the USB to any computer with Excel®. Open the **REPORT GENERATION WORKBOOK**. Click on the **LINData** tab. Press **Import Data from File** then choose the desired test data from the appropriate folder on the USB drive. Each time tests are exported from 699B07 to USB they are saved within a folder representing the date and time they were exported. Once data is imported press **View Certificate**. Enter any desired notes or comments into the report, save and/or print.

Note: Macros must be enabled for buttons to respond when clicked in Report Generation Workbook.

5.8 Troubleshooting The Proximity Probe System

If the vibration alarms did not activate at desired vibration thresholds the most common reason when using proximity probes is incorrect cabling. Advice on troubleshooting follows below. Be sure to read the previous section on confirming vibration alarms by dynamic linearity testing.

- Connect the output of the probe driver to **TEST SENSOR INPUT** BNC on model 699B07 calibrator while simulating vibration at the lowest alarm threshold. For a 5 or 8mm probe, is the sensitivity within 5% of 200 mV/mil? I.e. within 190-210 mV/mil or 7.08–8.66 mV/ μm ? The monitoring system likely is scaled for 200 mV/mil or 7.87 mV/ μm . If alarms did not activate it could be incorrect input sensitivity.

- Incorrect sensitivity is most often caused by incorrect cabling. Check the required length for the probe driver. Then check the length of the extension cable and integral cable on the probe itself. The probe cable length plus extension cable length should equal the required length for the probe driver.
- Make sure the probe was gapped properly prior to the test. See previous section.
- Ensure the proximity probe target is attached to the top of the shaker.
- Does the probe driver have a MOD? If so the probe driver may have been made for a different target material. The standard API 670 recommended target for testing proximity probes is 4140 steel. But custom proximity probe systems, calibrated to alternate materials, require a custom calibration target. Contact PCB Piezotronics for custom target materials.

5.9 Creating a Proximity Probe Curve in Mils

Note: Reference steps 1-5 of “Non-Contact Displacement Sensor Test Setup” section for setup instructions. This test assumes a 5 or 8mm proximity probe with 200 mV/mil output.

- Step 1** Power on the probe driver and connect a digital voltmeter to the output. Set the voltmeter to measure DC voltage.
- Step 2** Open the Report Generation Workbook and select the LINData tab. Choose Displacement for cell H12, Volts for cell I13 and mil p-p for cell H13.
- Step 3** Position the probe over the target using the micrometer such that -1.0 VDC reads on the voltmeter. Enter 10 into cell H14 next to “Starting Point” and enter -1.0 into cell I14 as a place holder. This value will be changed later.
- Step 4** Rotate the micrometer so that the proximity probe moves 10 mils further from the target. Each dash on the micrometer is one mil. Enter 20 mils into cell H15 and enter the DC voltage value read on the voltmeter into cell I15.
- Step 4a** Pay attention to micrometer looseness. All micrometers have looseness when changing directions where turning the micrometer does not move the probe. The looseness can be felt in your fingers as resistance is less than normal.
- Step 5** Repeat step 4 until the probe is 90 mils from the target. Each time the micrometer is turned 10 mils the probe moves 10 mils further from the target. Record the DC voltage at 10, 20, 30, 40, 50, 60, 70, 80 and 90 mils using column I in the workbook.
- Step 6** Once the 90 mils data point is recorded use the micrometer to move the probe 80 mils closer to the target. In this step the 10 mils DC voltage will be re-confirmed. Recall that -1.0 VDC was entered as a placeholder. Move the probe 80 mils closer so that it is 10 mils from target and re-write the DC voltage in cell I14.
- Step 6a** One full rotation of the micrometer is 25 mils. To accomplish step 6 quickly, complete three full rotations of the micrometer and then move 5 more mils.
- Step 7** All data is now entered, press View Certificate to view, edit, save and print the report.

Static Proximity Probe/4-20 mA Vibration Sensor Calibration Data Table				
		Max Linearity:	1.11	%
Index	Displacement mil p-p	Output Volts	Sensitivity Volts/mil p-p	Linearity %
Starting Point	10	-0.998		
1	20	-3.003	-0.20	0.000%
2	30	-5.041	-0.20	1.106%
3	40	-7.077	-0.20	0.042%
4	50	-9.093	-0.20	0.509%
5	60	-11.088	-0.20	0.548%
6	70	-13.063	-0.20	0.383%
7	80	-15.029	-0.20	0.115%
8	90	-16.999	-0.20	0.141%
9				
10				
11				
12				
13				
14				
15				
16				
17				
18				
19				
20				
21				
22				
23				
24				
25				

5.10 Testing 4-20 mA Vibration Transmitters

Loop-powered 4-20 mA vibration transmitters give an overall vibration level reading and interface directly with the plant PLC, DCS or SCADA system just as process instrumentation does. The most important function of these sensors and the control system to which they are connected is the vibration alarms:

- Step 1** Remove the vibration transmitter from the machine and mount to the shaker table. Users may need a mounting adaptor such as ¼" NPT available from PCB Piezotronics. The shaker table should be brought to the sensor.
- Step 2** Leave all connections as is this will test the sensor, cable, system, display and alarms.
- Step 3** Set the frequency to the running speed of the machine. It may be easier to use the CPM scale than Hz for this test (press frequency dial and enter sub-menu to change)
- Step 4** Set the amplitude to the first vibration alert or just greater than first alert, call the control room to confirm alert.
- Step 5** Set the amplitude to the second (severe) vibration alarm or just greater, call the control room to confirm alarm.
- Step 6** Confirm with control room displayed vibration matches that shown on the 699B07.
- Step 7** Continue testing at any additional vibration alarm points.

5.11 Creating a Test Report for 4-20 mA Vibration Transmitters

For safety or insurance audits it may be helpful to have test reports for 4-20 mA vibration transmitters. The 699B07 cannot read DC voltage or current, thus for this test a calibrated multi-meter (capable of measuring current) is required. **Also a USB to 24 VDC power supply can be optionally used to power the sensor using the USB connection on the 699B07. Contact IMI for ordering information. The following instructions include using a USB to 24 VDC power supply.** If it will not be used skip to step 5.

- Step 1** Mount the 4-20 mA vibration transmitter to the shaker table. Users may need a mounting adaptor such as ¼” NPT available from PCB Piezotronics.
- Step 2** Make sure the 699B07 is turned off, connect the sensor’s leads to appropriate positions on the power supply terminal block: +24 VDC, SIG IN and GND (ground). For example, for an IMI Sensors model 640B01 and series 052BR cable connect the RED wire to +24 VDC, the BLUE wire to SIG IN and the cable’s shield to GND.
- Step 3** Connect the DAQ BNC output to the calibrated multi-meter and set the meter to measure DC current. A BNC jack to banana plug is the simplest method of connection. BNC jack to banana plugs are commercially available from any electrical hardware store (IMI uses Pomona model 1269 BNC jack to banana).
- Step 4** Plug the power supply into the USB port on the 699B07.
- Step 5** Turn on the shaker table.
- Step 6** Open the Report Generation Workbook on a computer and click the LINData tab.
- Step 7** Under the “Static Proximity Probe/4-20 mA Vibration Sensor Calibration Data Table” at right, click cell H12 and choose appropriate scale (acceleration, velocity or displacement). For aforementioned model 640B01 “velocity” would be chosen.
- Step 8** In cell H13 select the appropriate sub-scale (for velocity: ips pk, ips RMS, mm/sec pk or mm/sec RMS). For IMI model 640B01 “ips pk” would be chosen.
- Step 9** In cell I13 choose “mA” as the output.
- Step 10** The starting point should be 0.0, record this in cell H14. Read the mA value on the multi-meter and record in cell I14.
- Step 11** For first amplitude test point, read vibration value from display of 699B07, record in column H then read mA value from multi-meter and record in column I. Repeat until test is complete.
- Step 12** When all data has been entered press “view certificate” and print or save. Optionally enter additional test data like model number, serial number, location and notes.

A good test is to take five test points (including zero), evenly spaced through the range. Be sure to confirm operation at vibration alarm points. Example test data for IMI Sensors model 640B01:



Static Proximity Probe/4-20 mA Vibration Sensor Calibration Data Table				
		Max Linearity:	0.37	%
Index	Velocity in/s pk	Output mA	Sensitivity mA/in/s pk	Linearity %
Starting Point	0	4.030		
1	0.25	8.040	16.04	0.000%
2	0.5	12.070	16.12	0.099%
3	0.75	16.100	16.12	0.216%
4	1	19.980	15.52	0.374%
5				

5.12 Maintenance

Recalibration and certification is recommended on an annual basis. Service of internal parts should only be performed by factory personnel. If the unit is removed from the case, the NIST calibration is void. Recertification can only be performed after re-assembly

PCB Piezotronics, Inc.
3425 Walden Avenue
Depew NY, 14043, USA

Phone: 716.684.0002
Fax: 716.684.0987
www.pcb.com
info@pcb.com

Model Number 699B07	PORTABLE VIBRATION CALIBRATOR		Revision: NR ECN #: 49538										
Performance Maximum Load Frequency Range(operating, 100 gram payload) Accuracy(10 Hz to 10 kHz) Accuracy (5 Hz to 10 Hz) Accuracy (Velocity (10 Hz to 1000 Hz)) Accuracy (Displacement (30 Hz to 150 Hz)) Amplitude Linearity(100 gram payload, 100 Hz) Distortion(100 gram payload, 30 Hz to 2 kHz) Maximum Amplitude(Acc 50 Hz, 10 gram payload) Maximum Amplitude(Vel 50 Hz, 10 gram payload) Maximum Amplitude(Displ 50 Hz, 10 gram payload) Maximum Amplitude(Acc 50 Hz, 500 gram payload) Maximum Amplitude(Vel 50 Hz, 500 gram payload)	ENGLISH 28.2 oz 5 to 10,000 Hz ± 3 % ± 5 % ± 3 % ± 3 % 1 % < 5 % 20 g pk 20 in/sec pk 150 mils pk-pk 2.5 g pk 3.5 in/s pk	SI 800 gm [1] 300 to 600,000 cpm ± 3 % ± 5 % ± 3 % ± 3 % 1 % [2] < 5 % [3] 196 m/s ² pk 500 mm/s pk 3.8 mm pk-pk 24.5 m/s ² pk 90 mm/s pk	OPTIONAL VERSIONS Optional versions have identical specifications and accessories as listed for the standard model except where noted below. More than one option may be used.										
Control Interface Test Operation Test Sensor In Bias Fault Indication (ICP® Sensors) External Source In (Max) Monitor Reference Out Display Units(Acceleration) Display Units(Velocity) Display Units(Displacement) Display Units(Frequency) Test Sensor Sensitivity	Manual (Closed Loop) or Semi-Automatic ICP, Voltage, Modulated Current, Chg, Diff Chg, Single-ended Chg (Ext Chg AMP Req'd) Yes 1V AC RMS 10 mV/g (nominal), Quartz Reference Accelerometer, BNC Jack Output g pk & RMS in/sec pk & RMS mils pk-pk Hz mV/EU, mA/EU, µA/EU, pC/EU	Manual (Closed Loop) or Semi-Automatic ICP, Voltage, Modulated Current, Chg, Diff Chg, Single-ended Chg (Ext Chg AMP Req'd) Yes 1V AC RMS 10 mV/g (nominal), Quartz Reference Accelerometer, BNC Jack Output m/s ² pk & RMS mm/sec pk & RMS um pk-pk CPM mV/EU, mA/EU, µA/EU, pC/EU [5]	NOTES: [1] Operating range reduced at higher payloads. Reference manual for full details. [2] Up to 10g pk [3] Up to 5g pk [4] 5 mA constant current excitation to ICP® (IEPE) sensor. [5] EU can be [g], [m/s ²], [mm/s], [in/s], [mils] or [um] [6] As shipped from factory in new condition [7] See PCB Declaration of Conformance PS146 for details.										
Environmental Temperature Range(Operating) Electrical Power Required(Internal Battery (sealed solid gel lead acid)) Power Required(Input from Charger) Power Required(AC Power (for recharging battery)) Battery Life(100 gram payload, 100 Hz 1g pk) Battery Life(100 gram payload, 100 Hz 10g pk)	32 to 122 °F 12 VDC, 4 amp hours 18 VDC, 1A 110-240 V, 50-60 Hz 18 hours 1 hour	0 to 50 °C 12 VDC, 4 amp hours 18 VDC, 1A 110-240 V, 50-60 Hz 18 hours 1 hour [6]	SUPPLIED ACCESSORIES: Model 081A08 Mounting Stud (10-32 to 1/4-28) (1) Model 081B20 Mounting Stud, with shoulder (1/4-28 to 1/4-28) (1) Model 081M165 Mounting Stud (M8 x 1 M to 1/2-28 M) (1) Model 600A25 Power Supply and Plug Adaptors (1) Model 600A34 Mounting Wrench (1) Model 600A54 Mounting Pad (M8 x 1.25 F) (1) Model 600A55 Mounting Pad (M8 x 1 F) (1) Model 600A56 Mounting Plate (3 and 4-Hole High-Temp Vibration Sensors) (1) Model 600A57 Mounting Plate (3 and 4 Hole High-Temp Vibration Sensors) (1) Model ICS-41 NIST traceable Certificate of Calibration, Metric & English Units (1) Model M081A63 Mounting stud, 1/4-28 to M8 x 1.25, BeCu with shoulder (1) Model USB DRIVE Flash Drive with Calibration Report Generation Worksheet (1)										
Physical Storage Points Per Record Sensor Information Export File Format USB Port Size (Width x Height x Depth) Weight Mounting Thread	Semi-Automated test routine calibration settings 30 calibration data points Model number, serial number, Mounting orientation (x, y, z), user notes CSV (comma-separated values) Loading Semi-Automating Test Routines Exporting Calibration Records in CSV Format 12 in x 8.5 in x 10 in 18 lb 1/4-28 Female	Semi-Automated test routine calibration settings 30 calibration data points Model number, serial number, Mounting orientation (x, y, z), user notes CSV (comma-separated values) Loading Semi-Automating Test Routines Exporting Calibration Records in CSV Format 30.5 cm x 22 cm x 28 cm 8.2 kg No Metric Equivalent	<table border="1"> <tr> <td>Entered: LK</td> <td>Engineer: KW</td> <td>Sales: MC</td> <td>Approved: BAM</td> <td>Spec Number:</td> </tr> <tr> <td>Date: 11/15/2019</td> <td>Date: 11/15/2019</td> <td>Date: 11/15/2019</td> <td>Date: 11/15/2019</td> <td>71335</td> </tr> </table>	Entered: LK	Engineer: KW	Sales: MC	Approved: BAM	Spec Number:	Date: 11/15/2019	Date: 11/15/2019	Date: 11/15/2019	Date: 11/15/2019	71335
Entered: LK	Engineer: KW	Sales: MC	Approved: BAM	Spec Number:									
Date: 11/15/2019	Date: 11/15/2019	Date: 11/15/2019	Date: 11/15/2019	71335									
 [7]	All specifications are at room temperature unless otherwise specified. In the interest of constant product improvement, we reserve the right to change specifications without notice. ICP® is a registered trademark of PCB Piezotronics, Inc.		 Phone: 800-959-4464 Fax: 716-684-3823 E-Mail: imi@pcb.com 3425 Walden Avenue, Depew, NY 14043										