



Model 3122-04A

Rotary Torque, Shaft-Shaft, High Speed, Low Capacity

Installation and Operating Manual

For assistance with the operation of this product, contact:

**PCB Load & Torque, Inc.
Toll-free: 866-684-7107
24-hour SensorLine™: 716-684-0001
Fax: 248-888-8266
E-mail: LTInfo@pcbloadtorque.com
Web: www.pcbLoadTorque.com**





Warranty, Service, Repair, and Return Policies and Instructions
--

The information contained in this document supersedes all similar information that may be found elsewhere in this manual.

Total Customer Satisfaction – PCB Piezotronics guarantees Total Customer Satisfaction. If, at any time, for any reason, you are not completely satisfied with any PCB product, PCB will repair, replace, or exchange it at no charge. You may also choose to have your purchase price refunded in lieu of the repair, replacement, or exchange of the product.

Service – Due to the sophisticated nature of the sensors and associated instrumentation provided by PCB Piezotronics, user servicing or repair is not recommended and, if attempted, may void the factory warranty. Routine maintenance, such as the cleaning of electrical connectors, housings, and mounting surfaces with solutions and techniques that will not harm the physical material of construction, is acceptable. Caution should be observed to insure that liquids are not permitted to migrate into devices that are not hermetically sealed. Such devices should only be wiped with a dampened cloth and never submerged or have liquids poured upon them.

Repair – In the event that equipment becomes damaged or ceases to operate, arrangements should be made to return the equipment to PCB Piezotronics for repair. User servicing or repair is not recommended and, if attempted, may void the factory warranty.

Calibration – Routine calibration of sensors and associated instrumentation is recommended as this helps build confidence in measurement accuracy and acquired data. Equipment calibration cycles are typically established by the users own quality regimen. When in doubt about a calibration cycle, a good “rule of thumb” is to recalibrate on an annual basis. It is also good practice to recalibrate after exposure to any severe temperature extreme, shock, load, or other environmental influence, or prior to any critical test.

PCB Piezotronics maintains an ISO-9001 certified metrology laboratory and offers calibration services, which are accredited by A2LA to ISO/IEC 17025, with full traceability to SI through N.I.S.T. In addition to the normally supplied calibration, special testing is also available, such as: sensitivity at elevated or cryogenic temperatures, phase response, extended high or low frequency response, extended range, leak testing, hydrostatic pressure testing, and others. For information on standard recalibration services or special testing, contact your local PCB Piezotronics distributor, sales representative, or factory customer service representative.

Returning Equipment – *Following these procedures will insure that your returned materials are handled in the most expedient manner.* Before

returning any equipment to PCB Piezotronics, contact your local distributor, sales representative, or factory customer service representative to obtain a Return **Warranty, Service, Repair, and Return Policies and Instructions** Materials Authorization (RMA) Number. This RMA number should be clearly marked on the outside of all package(s) and on the packing list(s) accompanying the shipment. A detailed account of the nature of the problem(s) being experienced with the equipment should also be included inside the package(s) containing any returned materials.

A Purchase Order, included with the returned materials, will expedite the turn-around of serviced equipment. It is recommended to include authorization on the Purchase Order for PCB to proceed with any repairs, as long as they do not exceed 50% of the replacement cost of the returned item(s). PCB will provide a price quotation or replacement recommendation for any item whose repair costs would exceed 50% of replacement cost, or any item that is not economically feasible to repair. For routine calibration services, the Purchase Order should include authorization to proceed and return at current pricing, which can be obtained from a factory customer service representative.

Warranty – All equipment and repair services provided by PCB Piezotronics, Inc. are covered by a limited warranty against defective material and workmanship for a period of one year from date of original purchase. Contact

PCB for a complete statement of our warranty. Expendable items, such as batteries and mounting hardware, are not covered by warranty. Mechanical damage to equipment due to improper use is not covered by warranty. Electronic circuitry failure caused by the introduction of unregulated or improper excitation power or electrostatic discharge is not covered by warranty.

Contact Information – International customers should direct all inquiries to their local distributor or sales office. A complete list of distributors and offices can be found at www.pcb.com. Customers within the United States may contact their local sales representative or a factory customer service representative. A complete list of sales representatives can be found at www.pcb.com. Toll-free telephone numbers for a factory customer service representative, in the division responsible for this product, can be found on the title page at the front of this manual. Our ship to address and general contact numbers are:

PCB Piezotronics, Inc.
3425 Walden Ave.
Depew, NY14043 USA
Toll-free: (800) 828-8840
24-hour SensorLineSM: (716) 684-0001
Website: www.pcb.com
E-mail: info@pcb.com



PCB工业监视和测量设备 - 中国RoHS2公布表
 PCB Industrial Monitoring and Measuring Equipment - China RoHS 2 Disclosure Table

部件名称	有害物质					
	铅 (Pb)	汞 (Hg)	镉 (Cd)	六价铬 (Cr(VI))	多溴联苯 (PBB)	多溴二苯醚 (PBDE)
住房	○	○	○	○	○	○
PCB板	X	○	○	○	○	○
电气连接器	○	○	○	○	○	○
压电晶体	X	○	○	○	○	○
环氧	○	○	○	○	○	○
铁氟龙	○	○	○	○	○	○
电子	○	○	○	○	○	○
厚膜基板	○	○	X	○	○	○
电线	○	○	○	○	○	○
电缆	X	○	○	○	○	○
塑料	○	○	○	○	○	○
焊接	X	○	○	○	○	○
铜合金/黄铜	X	○	○	○	○	○
本表格依据 SJ/T 11364 的规定编制。						
○：表示该有害物质在该部件所有均质材料中的含量均在 GB/T 26572 规定的限量要求以下。						
X：表示该有害物质至少在该部件的某一均质材料中的含量超出 GB/T 26572 规定的限量要求。						
铅是欧洲RoHS指令2011/65/ EU附件三和附件四目前由于允许的豁免。						

CHINA RoHS COMPLIANCE

Component Name	Hazardous Substances					
	Lead (Pb)	Mercury (Hg)	Cadmium (Cd)	Chromium VI Compounds (Cr(VI))	Polybrominated Biphenyls (PBB)	Polybrominated Diphenyl Ethers (PBDE)
Housing	O	O	O	O	O	O
PCB Board	X	O	O	O	O	O
Electrical Connectors	O	O	O	O	O	O
Piezoelectric Crystals	X	O	O	O	O	O
Epoxy	O	O	O	O	O	O
Teflon	O	O	O	O	O	O
Electronics	O	O	O	O	O	O
Thick Film Substrate	O	O	X	O	O	O
Wires	O	O	O	O	O	O
Cables	X	O	O	O	O	O
Plastic	O	O	O	O	O	O
Solder	X	O	O	O	O	O
Copper Alloy/Brass	X	O	O	O	O	O

This table is prepared in accordance with the provisions of SJ/T 11364.

O: Indicates that said hazardous substance contained in all of the homogeneous materials for this part is below the limit requirement of GB/T 26572.

X: Indicates that said hazardous substance contained in at least one of the homogeneous materials for this part is above the limit requirement of GB/T 26572.

Lead is present due to allowed exemption in Annex III or Annex IV of the European RoHS Directive 2011/65/EU.

DOCUMENT NUMBER: 21354

DOCUMENT REVISION: C

ECN: 45605

1.0 INTRODUCTION

Load Cells manufactured by the Force/Torque Division of PCB Piezotronics are designed to accurately measure static and quasi-static compressive and tensile forces ranging from 5 lbs. to 100k lbs. (22 to 4.45kN). All models utilize strain gages configured into a Wheatstone Bridge Circuit to produce the primary sensing element. The four-arm Wheatstone Bridge configuration is shown below in **Figure 1**.

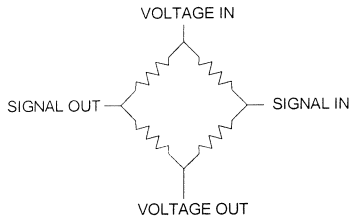

Figure 1 - Wheatstone Bridge Circuit

Most PCB load cells follow a wiring code established by the Western Regional Strain Gage Committee as revised in May 1960. The wiring code is as follows:

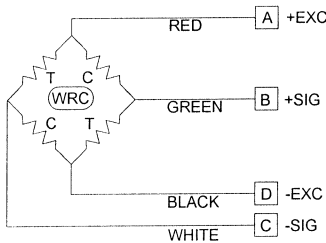

Figure 2 - Western Regional Strain Gage Committee Wiring Code

Refer to the wiring drawing included with this manual for specific wiring of the supplied load cell.

The gages are bonded to the load cell's structure. Typically, a regulated DC or AC excitation is applied between A and D of the bridge. When a force is applied to the load cell, the Wheatstone Bridge becomes unbalanced, causing an output voltage between B and C, which is proportional to the applied load. The magnitude of the output voltage corresponds to the deformation of the load cell and therefore the applied load. This configuration allows for temperature and pressure compensation, as well as cancellation of signals caused by forces not directly applied to the axis of the applied load. Output is typically expressed in units of millivolt per volt of excitation.

Optional signal conditioners are available from PCB. A signal conditioner may have analog voltage output, current output, or

digital output. Digital display signal conditioners are also available.

Axis Definition

PCB force products comply with the Axis and Sense Definitions of NAS-938 (National Aerospace Standard-Machine Axis and Motion) nomenclature and recommendations of the Western Regional Strain Gage committee. These axes are defined in terms of a "Right Handed" orthogonal coordinate system as show below.

A (+) sign indicates force in a direction that produces a (+) signal voltage and generally defines a tensile force. The primary axis of rotation or axis of radial symmetry of a load cell is the z-axis as defined in **Figure 3**.

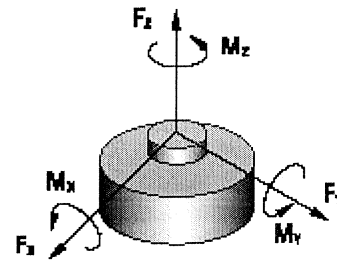

Figure 3 - Axis and Sense Nomenclature for PCB Load Cells

2.0 SAFETY INFORMATION

Failure of the load cell structure or fasteners used in the load cell installation may cause personal injury and equipment damage. To prevent structure failure, review the extraneous load limits listed on the load cell specification sheet supplied with this manual.

Loads must be limited to 100% of the measurement axis load combined with 200% of any one of the extraneous loads. To determine an acceptable level of extraneous loads that prevents output signal degradation, review the extraneous load limits and note on the specification sheet.

When selecting rod ends and fasteners for load cell installation, review the manufacturers data to determine if failure might occur due to combined measurement axis and extraneous loads.

3.0 MECHANICAL INSTALLATION

Refer to the outline drawing supplied with this manual for specific outline dimensions and installation details for your particular model. The specification is also included to provide details of the sensor's characteristic properties.

General Purpose Load Cells

It is important that the surface to which each load cell is mounted be clean and perfectly flat to avoid flexing of the base, which could affect sensor sensitivity and result in erroneous data. Ideally, surface flatness should be held to within 0.001" (TIR) over the entire mating surface. Ensure that the sensor is correctly aligned and oriented, and that it is mounted with proper torque and hardware.

If the load cell is used in an application where both tension and compression forces are applied, use spherical rod end bearings to eliminate bending loads. A load button should be used in compression-only applications.

Extraneous loads, such as bending moments and side loads, may reduce measurement accuracy and cause structure damage. Install the load cell in a manner that minimizes these loads.

Fatigue Rated Load Cells

Fatigue rated load cells are specially designed and manufactured to withstand millions of cycles. They are manufactured using premium fatigue resistant steel and special processing to insure mechanical and electrical integrity as well as accuracy. Fatigue rated load cells manufactured by the Force/Torque Division are guaranteed to last 100 million fully reversed cycles (full tension through zero to full compression). An added benefit of fatigue rated load cells is that they are extremely resistant to extraneous bending and side loading forces.

Mounting Bases

All low-profile load cells are calibrated with a mounting base. An optional mounting base, if purchased with a load cell, is pre-installed at the factory. Unless otherwise specified, the base and load cell are calibrated as a unit. It is important to note that the performance of the load cell may be affected if the factory-installed mounting base is removed or modified.

Steel hex head cap screws used in mounting load cells must be rated Grade 8 or better. Screws should be fastened in a criss-cross pattern, and tightened to the appropriate torque value listed below.

Screw Thread	Torque (foot-pounds)
1/4"-28	15
3/8"-24	50
1/2"-20	130
5/8"-18	260

Figure 4 – Screw Torque Values

Rod-Style Load Cell

Loads applied to rod-style load cells must be even and centered. Compensation linkages (e.g. rod end bearings, alignment couplers) are recommended to help minimize load

misalignment. When installing fixtures, thread the fixture to the load cell, not the load cell to the fixture. If alignment fixtures are not used, insure loading surfaces are flat and parallel, with loads applied in line with the sensor.

S-Beam Load Cell

S-beam load cells can be mounted in a variety a ways, depending on the end use of the sensor. In tension applications, loads must be applied in line, centered on the sensor. To insure optimum loading, compensation linkages such as rod end bearings and alignment couplers are recommended.

In compression applications, loads must be applied even and centered. Load surfaces must be clean, flat and parallel. A load button mounted to the top of the sensor, with the sensor bottom secured to a base plate, provides a reliable mounting arrangement.

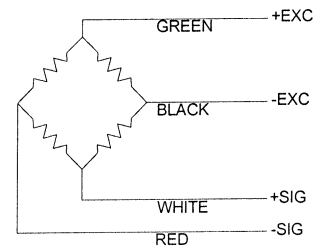

Figure 5 - S-Beam Load Cell Wiring Diagram

If fixtures are mounted to the load cell, be sure to thread the fixture to the load cell. Threading the load cell to the fixture may inadvertently apply a torque load that could damage the sensor.

Hollow Compression Load Cells

Hollow compression load cells feature a smooth thru-hole design that allows a load structure to pass directly through the load cell itself. The load structure must contact the top inner ring only, and the support fixture must contact the lower outer ring only. Hardened washers are supplied and should be used between the load cell and mounting surfaces to obtain the best performance.

Load Washer

Load washer load cells were originally designed to determine the clamp force vs. torque on fasteners. As torque is applied to a fastener, a tensile loading occurs on the fastener, which results in compression load on the load cell. Hardened washers are supplied and should be used between the load cell and mounting surfaces to obtain the best performance.

Load Button

Load buttons are compact, compression-only load cells with an integral spherical loading surface. It is extremely important that the mounting surface is clean, flat and even. Loads must be applied in line on the center of the button to insure optimum sensor performance. Loads must not contact the sensor diaphragm. Fixtures used with load buttons must be oriented in line with the sensor.

4.0 ELECTRICAL INSTALLATION

For proper electrical connections, refer to the installation drawing for the load cell, and the wiring drawing for the signal conditioner used. Construct the interconnect cable from high-quality shielded instrumentation cable. Various cable assemblies are available through PCB.

Connect one end of the cable to the sensor connector and the other end to the signal conditioner. Make sure to tighten the cable connector to the sensor. For installation in dirty, humid, or rugged environments, it is suggested that the connection be shielded against dust or moisture with shrink tubing or other protective material. Strain relieving the cable/sensor connection can also prolong cable life. Mounting cables to a test structure with tape, clamps, or adhesives minimizes cable whip. (See **Figure 6** for an example of a sensor installation with a securely fastened cable.)

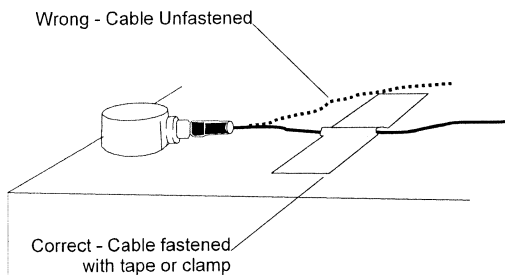

Figure 6 - Cable Strain Relief

5.0 POLARITY

Compressive forces upon standard PCB tension/compression load cells produce a negative-going voltage output. Tensile forces produce a positive-going voltage output.

Compressive forces upon a compression-only load cell produce a positive-going signal.

6.0 SHUNT CALIBRATION

Shunt calibration is the known, electrical, unbalancing of a strain gage bridge by means of a fixed resistor that is placed, or “shunted”, across one leg of the bridge. The “Wheatstone Bridge” utilized by PCB load cells are typically calibrated using the shunt calibration technique.

Shunt calibration is a method of periodically checking the gain or span of a signal conditioner, which is used in conjunction with a strain gage based transducer, without exposing the transducer to known, traceable, physical input values. If required, adjustments can then be made to the signal conditioner to insure accurate measurement results.

The strain gage bridge is “in balance” when the host mechanical structure is unloaded and unstressed. As the host structure (diaphragm, bending beam, shear beam, column, etc.) is loaded or stressed, the Wheatstone Bridge becomes unbalanced, resulting in an output signal that is proportional to the applied load.

Shunt calibration simulates the mechanical input to a transducer by unbalancing the bridge with a fixed resistor placed across, or in parallel with, one leg of the bridge. For tension shunt calibration, or +CAL, the shunt resistor (R_{st}) is shunted across the +Excitation (A) and +Signal (B) leg of the bridge. For compression shunt calibration, or -CAL, the shunt resistor (R_{sc}) is shunted across the -Excitation (D) and +Signal (B) leg of the bridge. Refer to **Figure 7** for shunt resistor locations in the Wheatstone Bridge circuit.

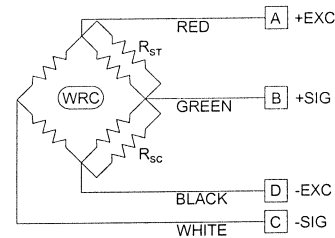

Figure 7 - Shunt Resistor Locations

Shunt calibration is accepted throughout the industry as a means of periodic calibration of a signal conditioner and transducer between calibrations of known, applied, traceable, mechanical, input values. Consequently, most all strain gage transducer manufacturers collect and supply shunt calibration data, along with a shunt calibration resistor, as a standard feature.

Shunt Calibration Procedure

1. Connect the transducer to an appropriate strain gage signal conditioner and allow adequate time for the system to stabilize.
2. Apply a full-scale, N.I.S.T. traceable, mechanical input (or load) to the transducer.
3. Adjust the signal conditioner's gain or span controls, as required, to obtain a full-scale electrical output signal, and/or numeric display that represents the applied, mechanical input quantity.
4. Remove the mechanical input (or load).

Shunt Calibration Procedure – continued

5. Place the shunt calibration resistor across an appropriate leg of the Wheatstone Bridge as discussed above.
6. Record the value of the signal conditioner's output signal and/or numeric display. This value is the shunt calibration value, or equivalent load.
7. It is important to note that the shunt calibration value is specific for the particular shunt resistor used. This value, and the particular resistor, are now matched to the transducer and form a basis of the transferable shunt calibration.

7.0 OPERATION

Typical Load Cell System Configurations

Operation requires the connection of the load cell to a signal conditioner, then to a readout device (if signal conditioner does not have a display). Strain gage signal conditioners and cable assemblies are available from PCB.

Operation with a Signal Conditioner

The signal conditioner span and zero must be set before the load cell system can be used. The span can be set using dead weights or the shunt calibration value. Refer to the shunt calibration information in this manual, and the signal conditioner instruction manual, for proper set-up information.

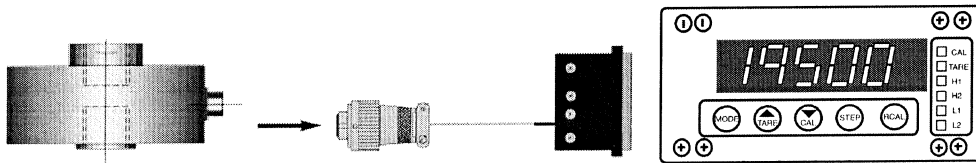

Figure 8 - Typical Load Cell System Configuration

8.0 TROUBLESHOOTING

No output

- ✓No power
- ✓Loose or dirty connections
- ✓Circuit opens or shorts
- ✓Faulty or improper wiring
- ✓No load applied

Erratic or Improper Readings

- ✓Excitation voltage drift
- ✓Electrical noise
- ✓Loose fixturing
- ✓Circuit opens or shorts
- ✓Improper load applied
- ✓Cable too long

Blinking Display

- ✓Overload condition
- ✓Open circuit

Zero Balance

- ✓Load applied to sensor
- ✓Overloaded or side-loaded sensor
- ✓Open circuit
- ✓Improper electrical connections

Zero Shift

- ✓Fixture preload
- ✓Faulty or improper wiring
- ✓Improper tare

Zero Drift

- ✓Unconditioned power supply
- ✓Circuit opens or shorts
- ✓Loose wiring
- ✓RFI/EMI interface
- ✓Temperature change

Damaged or Deformed Equipment

- ✓Improper use

Often overlooked by the customer, is the error due to the presence of non-measured forces and bending moments. Even Though the Single Axis of Measurement sensors are designed and built to withstand these non-measured forces and bending moments (extraneous loads), the errors due to them are present. PCB engineers can design the set-up to eliminate or minimize these extraneous loads. However, if these extraneous loads are present, the errors due to them should be considered. Due to cost restraints, the Force/Torque Division, as with its competition, does not typically measure or compensate for errors due to extraneous loads. If the presences of these extraneous loads are known, the user should request the transducer manufacturer to run a special test, at extra cost, to define and quantify the extraneous load errors. These errors are defined as cross-talk errors.

Error Analysis

The Force/Torque Division typically supplies accuracy information on its products in the form of individual errors (see specification sheet). They are: Non-Linearity, Hysteresis, Non-Repeatability, Effect of Temperature on Zero, and Effect of Temperature on Output.

The customer can combine these individual errors to establish the maximum possible error for the measurement or just examine the applicable individual error. If the temperature remains stable during the test, temperature related errors may be ignored. If the sensor is used for increasing load measurement only, ignore the Hysteresis error. If the load measurement is near the full capacity, the linearity error can be ignored. If the capability exists to correct the data through linearization-fit or a look-up-table, the error in the measurement can be minimized. A sophisticated user can get rid of all the errors except for the non-repeatability error in the measurement.

9.0 MAINTENANCE

Routine maintenance, such as cleaning of electrical connectors, housings, and mounting surfaces with solutions and techniques that will not harm the physical material of construction is acceptable. Caution should be observed to insure that liquids are not permitted to migrate into devices that are not hermetically sealed. Such devices should only be wiped with a damp cloth and never submerged or have liquids poured on them.

Model Number 3122-04A	ROTARY TORQUE, SHAFT-SHAFT, HIGH SPEED, LOW CAPACITY			Revision: A ECN #: 37309										
Performance Measurement Range(Full Scale Capacity) Sensitivity(output at rated capacity) Non-Linearity Hysteresis Non-Repeatability	ENGLISH 88.5 in-lb 1.5 mV/V $\leq 0.1\%$ FS $\leq 0.1\%$ FS $\leq 0.05\%$ FS	SI 10 Nm 1.5 mV/V $\leq 0.1\%$ FS $\leq 0.1\%$ FS $\leq 0.05\%$ FS	[4] [2] [2] [2]	OPTIONAL VERSIONS Optional versions have identical specifications and accessories as listed for the standard model except where noted below. More than one option may be used.										
Environmental Overload Limit Temperature Range(Operating) Temperature Range(Compensated) Temperature Effect on Output(Maximum) Temperature Effect on Zero Balance(Maximum)	177 in-lb 0 to 200 °F 70 to 150 °F $\pm 0.002\%$ Reading/°F $\pm 0.002\%$ FS/°F	20 Nm -18 to 93 °C 21 to 66 °C $\pm 0.0018\%$ Reading/°C $\pm 0.0018\%$ FS/°C	[3] [3]	NOTES: [1] Recommended 10 VAC RMS. [2] FS - Full Scale. [3] Over compensated operating temperature range. [4] Nominal. [5] See 45871 for dimensional drawing.										
Electrical Bridge Resistance Excitation Voltage Insulation Resistance Zero Balance Bridge Current(at 5 VAC)	350 Ohm 20 VDC or VAC rms >5 GOhm $\leq 2\%$ FS 50 mA	350 Ohm 20 VDC or VAC rms >5 GOhm $\leq 2\%$ FS 50 mA	[1] [2]											
Physical Size (Shaft Length x Housing Length x Housing Height)	6.50 in x 3.44 in x 3.50 in	165.1 mm x 87.4 mm x 88.9 mm	[5]											
Weight Mounting Sensing Element Housing Material Shaft Material Electrical Connector Torsional Stiffness Rotating Inertia Maximum Speed	2 lb Keyed Shaft Strain Gage Aluminum Stainless Steel PT02H-8-4P 12.4 kin-lb/radian 0.42 in-lb/sec ² 10,000 RPM	0.9 kg Keyed Shaft Strain Gage Aluminum Stainless Steel PT02H-8-4P 12.4 kin-lb/radian 0.42 in-lb/sec ² 10,000 RPM		<table border="1"> <tr> <td>Entered: AP</td> <td>Engineer: PE</td> <td>Sales: KWW</td> <td>Approved: DA</td> <td>Spec Number:</td> </tr> <tr> <td>Date: 7/17/2013</td> <td>Date: 7/17/2013</td> <td>Date: 7/17/2013</td> <td>Date: 7/17/2013</td> <td>45867</td> </tr> </table>	Entered: AP	Engineer: PE	Sales: KWW	Approved: DA	Spec Number:	Date: 7/17/2013	Date: 7/17/2013	Date: 7/17/2013	Date: 7/17/2013	45867
Entered: AP	Engineer: PE	Sales: KWW	Approved: DA	Spec Number:										
Date: 7/17/2013	Date: 7/17/2013	Date: 7/17/2013	Date: 7/17/2013	45867										
<i>All specifications are at room temperature unless otherwise specified. In the interest of constant product improvement, we reserve the right to change specifications without notice. ICP® is a registered trademark of PCB Group, Inc.</i>	<div style="display: flex; justify-content: space-between; align-items: center;">  <div style="text-align: right;"> <p>PCB Load & Torque, Inc. 24350 Indoplex Circle Farmington Hills, MI 48335 UNITED STATES Phone: 866-684-7107 Fax: 716-684-0987 E-Mail: Itinfo@pcbloadtorque.com Web site: http://www.pcbloadtorque.com</p> </div> </div>													

PCB Piezotronics Inc. claims proprietary rights in the information disclosed herein. Neither it nor any reproduction thereof will be disclosed to others without written consent of PCB Piezotronics Inc.

REVISIONS		
REV	DESCRIPTION	ECN
NR	RELEASED TO DRAFTING	33340

45871

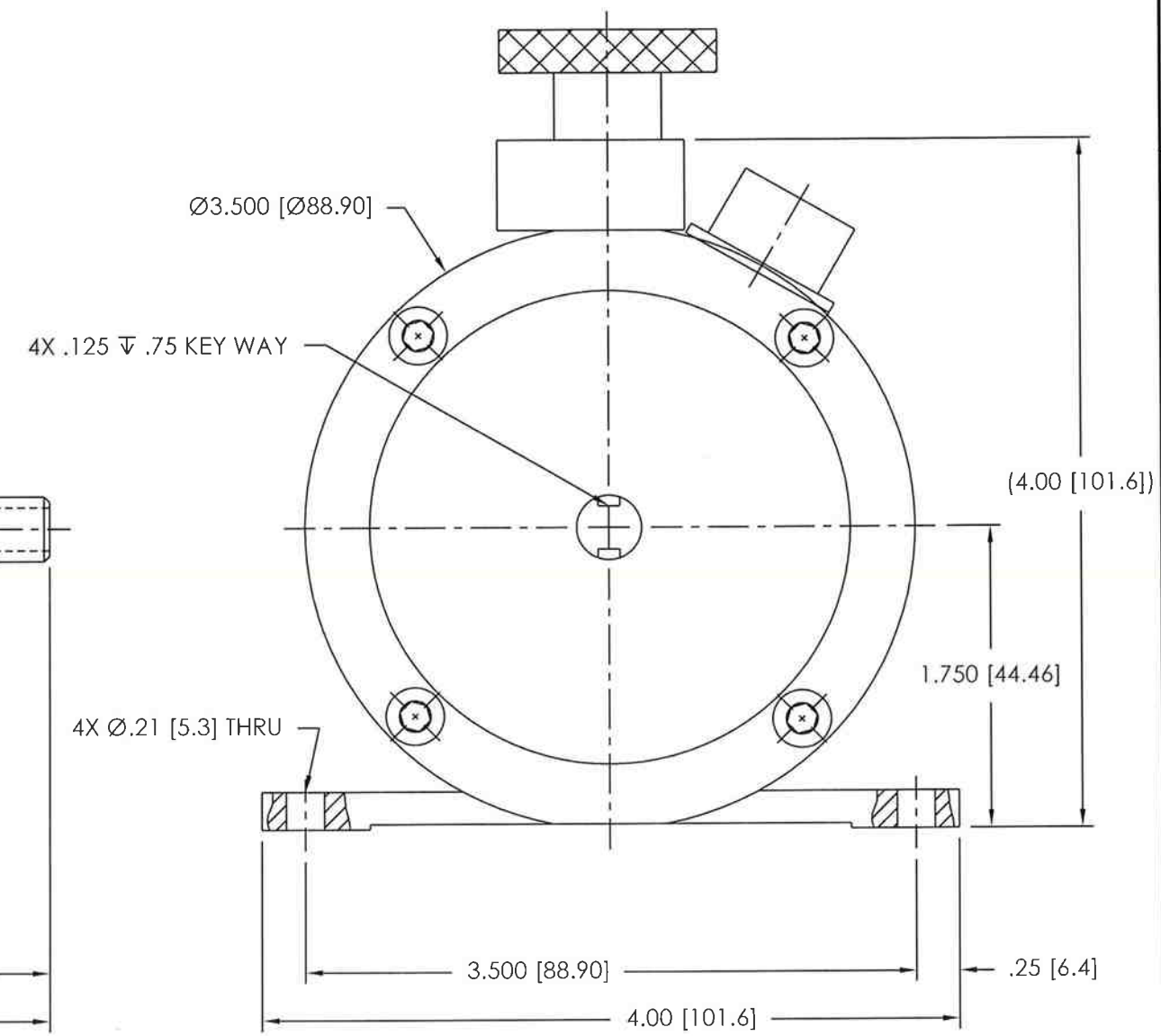
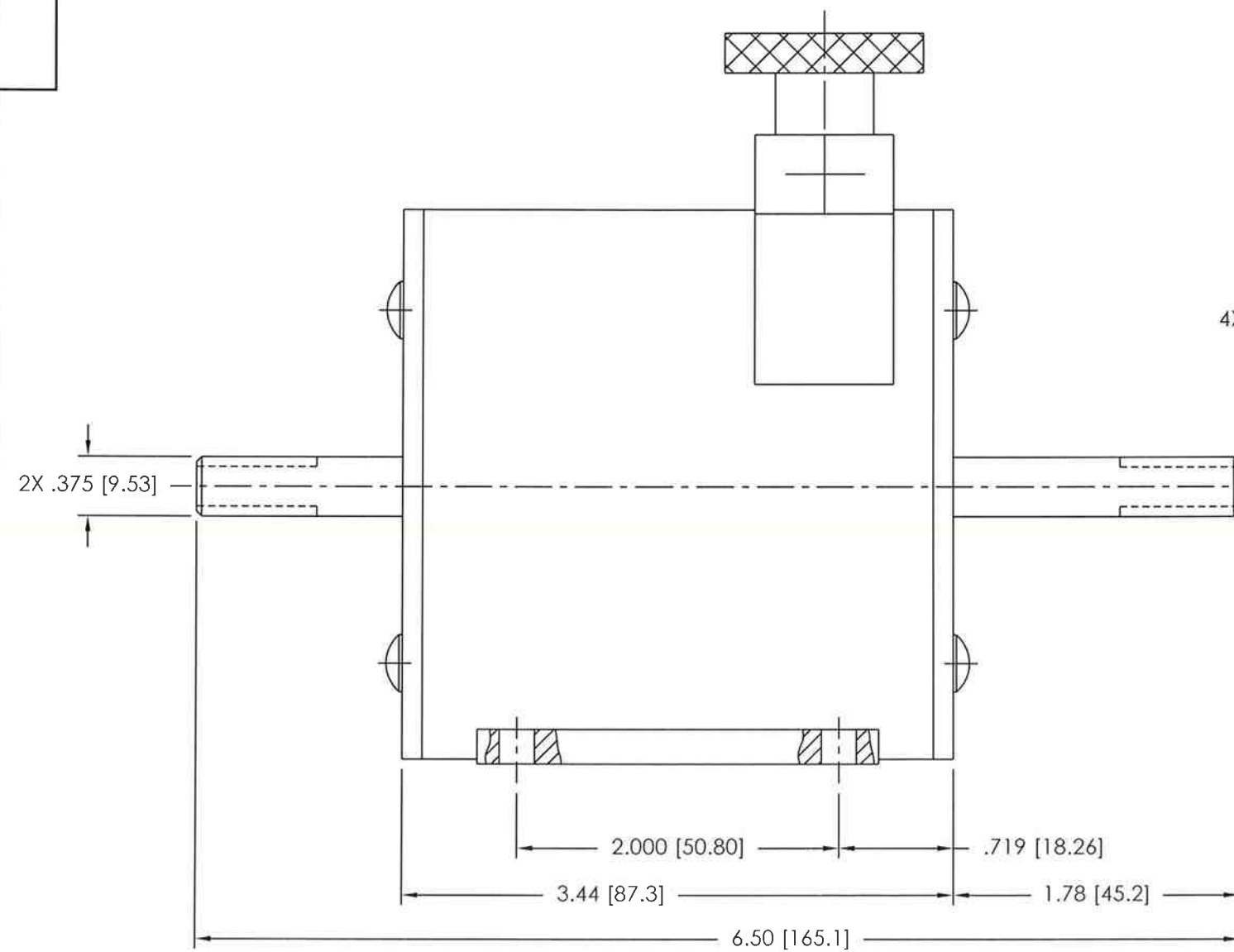

UNLESS SPECIFIED TOLERANCES	
DIMENSIONS IN INCHES	DIMENSIONS IN MILLIMETERS [IN BRACKETS]
DECIMALS XX ±.01 XXX ±.005 ANGLES ±.5 DEGREES	DECIMALS X ±0.3 XX ±0.13 ANGLES ±.5 DEGREES
FILLETS AND RADII .015 MAX	FILLETS AND RADII [0.07 - 0.13]

DRAWN	CHECKED	ENGINEER
<i>853/110</i>	<i>MDF</i>	PTE
	7/1/10	6/28/10

TITLE
OUTLINE DRAWING
MODELS 3122 SERIES
ROTARY SHAFT TORQUE SENSOR

PCB LOAD & TORQUE
 A PCB GROUP COMPANY
 24350 INDOPLEX CIRCLE, FARMINGTON HILLS, MI 48335
 (716) 684-0001 E-MAIL: llinfo@pcbloadtorque.com

CODE IDENT. NO. 52681
 DWG. NO. 45871

SCALE: FULL SHEET 1 OF 1